



Smart Series

Smart Electric
Protection Device Series



www.elcb.net elcb@elcb.net

tongou

Benefit
Your Life



Download specified APP control settings



Smart Electric Protection
Energy Management System



317.50
Recharge

www.elcb.net
elcb@elcb.net

About Tongou

80 + Staff

Strong production team excellent after-sales service

30 + Years

Rich professional and customer service experience

3000 + Customers

Rich customer solutions and experience

8000m² + Area

Rapid order fulfillment capabilities and intelligent production workshops

20 + R&D Engineers

Strong R&D capabilities to meet various development needs.

tongou, established in 1993, is renowned for its expertise in high-end, low-voltage electrical system solutions. We are committed to alleviating the challenges faced by our customers and consistently strive to add value through our offerings. Our extensive range of electricity safety products caters to household, commercial, industrial, and various other installations. This range includes Miniature Circuit Breakers (MCB), Residual Current Circuit Breakers (RCCB), Residual Current Circuit Breakers with Over-current Protection (RCBO), Switch-Disconnectors, Distribution Boxes, Moulded Case Circuit Breakers (MCCB), and Air Circuit Breakers (ACB).

A standout in our product line is our innovative Internet of Things (IoT) smart circuit breakers. These state-of-the-art devices represent the cutting edge of electrical safety and management technology. Integrated with IoT capabilities, these smart circuit breakers offer remote monitoring and control, allowing users to manage their electrical systems with unprecedented ease and precision. They provide real-time data on electrical usage, detect irregularities, and can automatically shut off power in case of faults, significantly enhancing safety. Furthermore, their predictive maintenance capabilities ensure timely alerts before potential issues escalate, thereby minimizing downtime and maintenance costs. By combining robust electrical protection with advanced connectivity and data analytics, our IoT smart circuit breakers are at the forefront of electrical safety innovation, delivering enhanced efficiency, safety, and control to our customers.

I Contents

Applicable Scenarios and Product Feature	P4 - P9
Smart Circuit Breaker - TOQCB2 Series	P10 - P19
Smart Circuit Breaker - TOQCB2L Series	P20 - P27
Smart Circuit Breaker - TOSMR1 Series	P28 - P31
DIN Rail Smart Switch - TO-Q-SY1 TO-Q-SY2 Series	P32 - P39
DIN Rail Smart Meter - TO-Q-SYS Series	P40 - P43
Smart Energy Accessory - TO-Q-SA1 Series	P44 - P48

I Applicable Scenarios

Extensive scenario applications, controlling and managing a variety of devices.

∨
Electric energy reserve

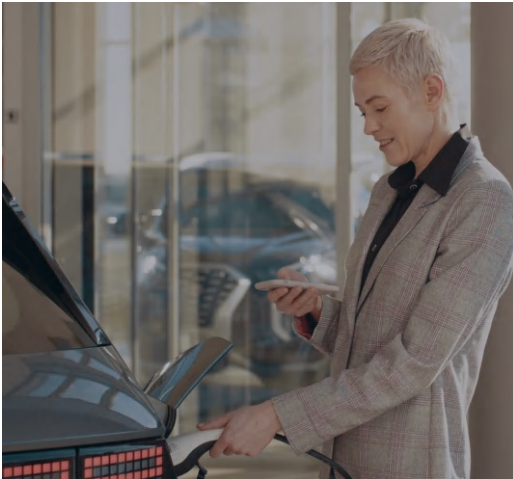

Energy industry

Control and manage household electricity, urban energy, commercial energy, and industrial energy.



Security industry

Control and manage surveillance security equipment, intelligent automation devices, and base station tower equipment



Sockets

For powering, monitoring controlling various devices.



Solar Energy

For solar power distribution system and energy monitoring management.



Switches

For turning on/off lights and other electrical appliances, with remote and timed control capabilities.



Wind Energy

For wind power generation and distribution system with energy monitoring and management.



Home Appliances

For daily household tasks and convenience, featuring timed operation, scenario linkage, and energy monitoring.



Utility Power

For controlling, managing, and configuring grid electricity.



Lighting

For indoor and outdoor illumination needs, with various timing settings and automated scene capabilities.



Security

For surveillance and protection of property and assets.



Charging Piles

For electric vehicle charging and power management.



DIY Devices

For custom home automation and control solutions.

I Product Feature

Rich functional settings, more flexible, reliable, and safe.



Flexible installation and configuration



Suitable for most distribution cabinet installation systems, supports various protocols, and allows for flexible configuration.



Remote Control

Control and obtain device information anytime, anywhere.



Operation Log

To record all information about events, setting operations, and recharges for easy viewing.



Voice Control

Supports mainstream voice speakers like Amazon Alexa, Google Assistant, etc., allowing for control, settings, and data retrieval through voice commands.



Multiple Timing

Timing, countdown, cyclic timing, sunrise and sunset timing.



Electricity Consumption

Record daily/monthly/yearly electricity usage logs for easy reference.



Circuit Protection

Overload, overcurrent, overvoltage, undervoltage, and fire protection to make the circuit safer.



Real-Time Power / Current / Voltage

Real-time data can be viewed on the interface.



Temperature Protection

Flexible application in different scenarios with detection and protection of the operating environment and terminal temperature of the equipment.



DIN Rail Installation

Rail mounted installation, standard modular dimensions.



Maintenance Mode

Maintenance circuit activated, network signal disconnected, local operation only, to avoid the risk of remote misoperation.



Leakage protection

Detecting and displaying the leakage current value of the circuit to prevent personal electric shock accidents.

I Network Configuration

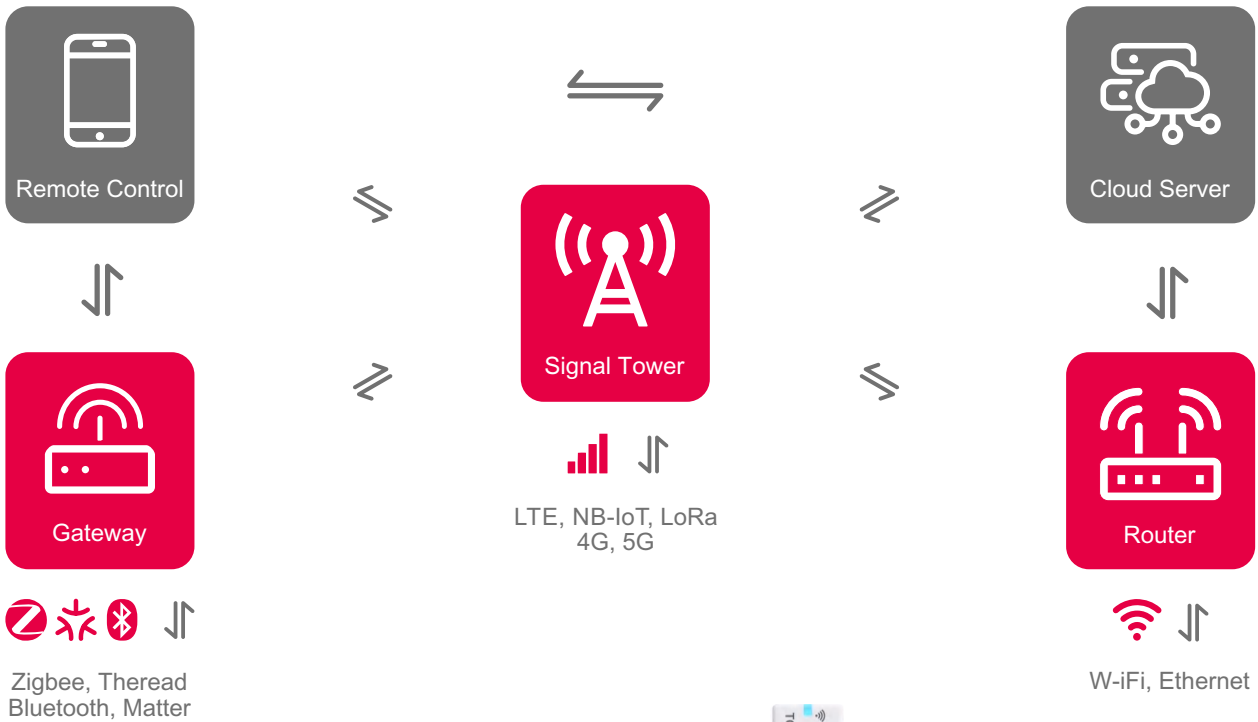

Voice Control



Amazon Alexa GoogleAssistant SmartThings Apple HomeKit

The smart electric protection device series represents cutting-edge electrical security supervision and power management solutions, embodying the synergy of state-of-the-art hardware and software components. This innovative system integrates local automation, cloud data interaction, multi-platform data interaction, and AI intelligence to deliver unparalleled performance and efficiency. By harnessing the power of AI algorithms and leveraging large amounts of data, intelligent monitoring, predictive analytics, and proactive management of electrical systems are ensured to improve safety, optimize energy usage, and maximize operational reliability.

I Benefits

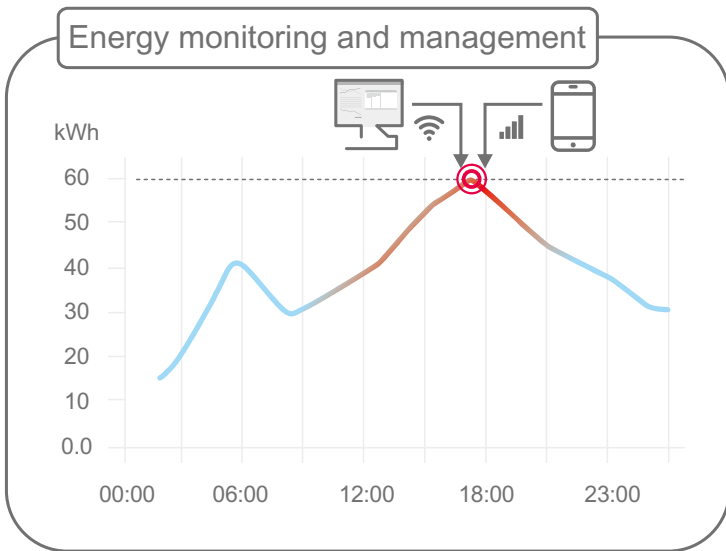
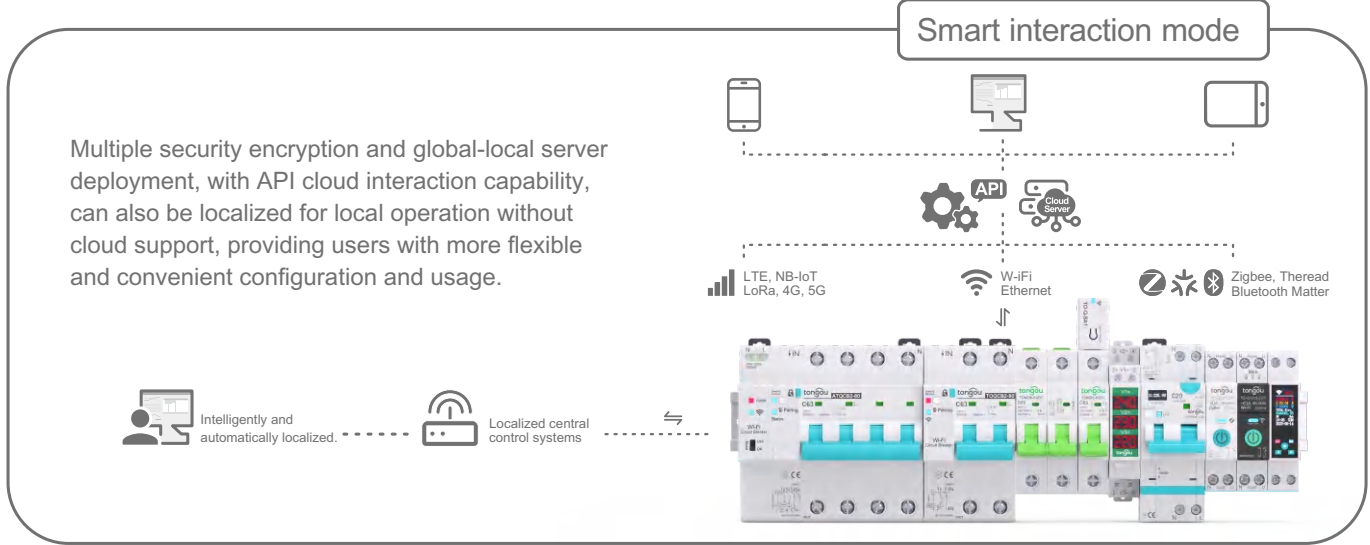

Real-time monitoring and viewing of equipment electricity usage, providing detailed insights into expenses, and promptly addressing any equipment electricity issues.

Remote electricity usage safety management

Remote monitoring of equipment and circuits
Receive fault reports of equipment and circuits in real-time, analyze them, and issue instructions promptly.

Multiple protection functions
Over-current, short-circuit, over-power, over-voltage, under-voltage, high temperature, arc fault, and phase loss protection are included.

Reliable mechanical structure
The mechanical part of the main body has passed international IEC electrical standard tests, ensuring normal local protection operation even if network signals and software fail.

Cloud network security
Cloud support is provided by leading cloud server providers such as Amazon Cloud, Alibaba Cloud, Tencent Cloud, and other localized deployments.

I App operating interface

About Smart Electric App

Discover our 24/7 accessible application for accessing our app services. Download and register for usage according to the user manual provided on our respective product.

Top features at a glance



Homepage: Clear visibility of current electric current, voltage, temperature, and equipment operation status.



Ele: Real-time monitoring of electricity consumption, recording daily, yearly, and monthly electricity consumption data.



Timer: Provides various timing functions including one-time timing, cyclic timing, and sunrise-sunset timing.



Log: Record every operation data, event information, operational status, and recharge records.



Setting: Set up functions and threshold values according to different products.

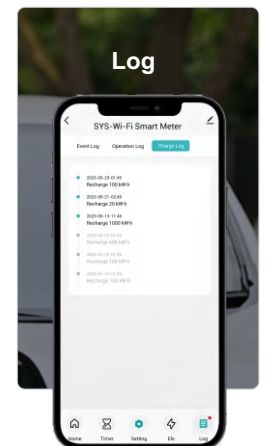
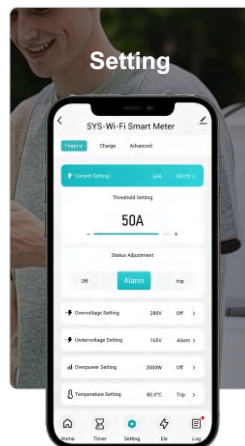
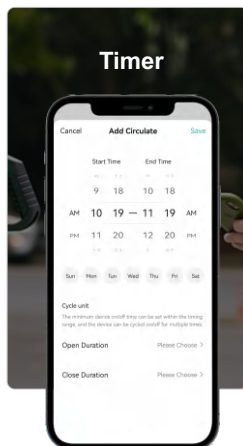

I Integrated Application

The smart electric protection device

Series is based on standardized integration and installation environments, giving it greater flexibility and making it more suitable for applications in different fields.

In the industrial sector, the solution can be installed in small to medium-sized factories, infrastructure, and processing plants for monitoring and remote control. By utilizing data analysis, it aims to minimize downtime and ensure equipment and circuit safety.

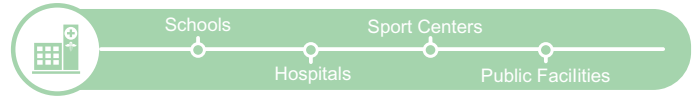

In the agricultural farming and irrigation sector, real-time collection of equipment usage data enables timely receipt of real-time data on equipment operation and faults. This addresses issues such as delayed monitoring and difficulty in manual operation due to long distances and wide coverage in farming and irrigation, thus mitigating potential property losses.

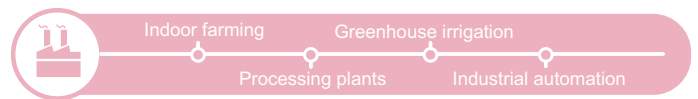

Commercial and public buildings can also utilize the scalable solution to enhance energy efficiency and achieve more detailed monitoring and control of their facilities. Offices, shopping malls, hotels, retail or chain stores can enhance their awareness of energy consumption and cost allocation to improve performance.

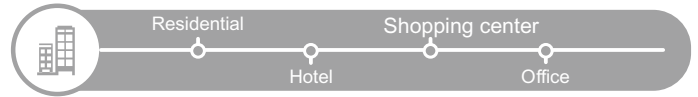

Public facilities such as schools, sports centers and medical care, Unified monitoring and management can ensure the standardized use of electrical equipment, the safety of circuits, and the continuity of services, and reduce safety hazards.

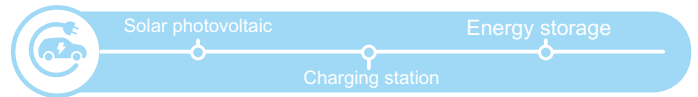

In the smart home scenario, utilizing DIN rail-mounted standardization and modular installation methods for household terminal distribution boxes can achieve functions such as remote control, automation control, and energy management, thereby enhancing the comfort, convenience, and energy efficiency of home living.

In the new energy and solar photovoltaic industry, safety monitoring and protection are conducted for electrical faults such as power faults, arc faults, overloads, and short circuits in circuits. Real-time monitoring of circuit parameters, electricity consumption data, and system operation status is available to optimize energy distribution and utilization. Predictive maintenance based on recorded data helps improve system reliability and stability.



Residential



Factory



Hotel

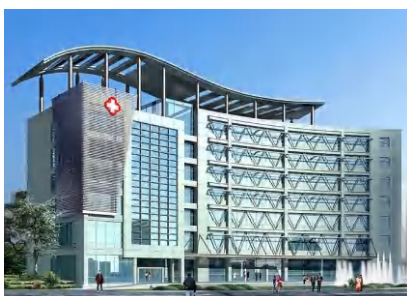

Hospital



Solar photovoltaic



Office

Smart Circuit Breaker TOQCB2 Series

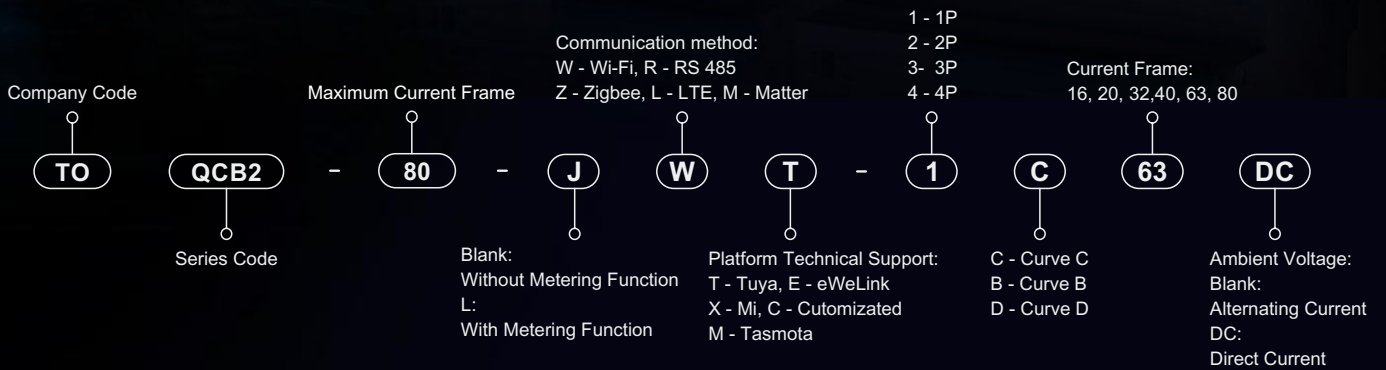

Smart Circuit Breaker **TOQCB2 Series**

The future mode of electricity usage will feature efficient energy management, enhanced safety with integrated electrical protection functions, remote monitoring of electricity data, more convenient and rapid power maintenance, and integrated application with intelligent automation systems.



Remote Control



Voice Control



Time Mode



Circuit Protection



Electricity Consumption



Real-Time Power / Current / Voltage



Temperature Protection



Operation Log



DIN Rail Installation



Maintenance Mode

I TOQCB2-80 1P

⚡ Over-current Protection

Threshold Setting: 1 - 63A
 Default: 63A
 Status Setting: Off/Alarm/Trip
 Electronic Component Response Time: 3s

+⚡ Over-voltage Protection

Threshold Setting: 245V - 295A
 Default: 280V
 Status Setting: Off/Alarm/Trip
 Electronic Component Response Time: 3s

-⚡ Under-voltage Protection

Threshold Setting: 145V - 220A
 Default: 165V
 Status Setting: Off/Alarm/Trip
 Electronic Component Response Time: 3s

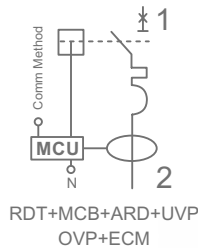

LED Indicator

- The switch Status LED steady blue, indicating that circuit breaker is disconnected.
- The switch Status LED steady red, indicating that circuit breaker is closed.
- The network LED flashing red slowly indicates that circuit breaker is in off-grid mode.
- The network LED flashing red quickly indicates that circuit breaker is in pairing mode.
- The network LED flashing blue slowly indicates that the circuit breaker is in the connected mode.

PRODUCT MODEL	TOQCB2-80-JW	TOQCB2-80-JZ	TOQCB2-80-JR	TOQCB2-80-JL	TOQCB2-80-JM
Standards	IEC/EN 60947, IEC/EN 60898, IEC/EN 50557, EN 301 489, EN 300 328, EN IEC 61000				
Poles Description	1P				
Operating Rated Voltage	Ue (V)	AC 145V - 230V			
Frequency	Hz	50/60Hz			
Current Frame	In (A)	16, 20, 32, 40, 63, 80			
Curve Code		B, C, D			
Rated Insulation Voltage	Ui (V)	AC 500V			
Rated Ultimate Short-circuit Breaking Capacity	Icu (kA)	10kA			
Short Circuit Protection	acc. to IEC/EN 60947-2, IEC/EN 60898-1				
Operational Safety	Physical Safety Lock, which prevents the device from being closed once engaged				
Communication Protocol	TOQCB2-80-JW	TCP/IP: Wi-Fi (2.412~2.484GHz) IEEE 802.11b/g/n			
	TOQCB2-80-JZ	Zigbee (2.400~2.483GHz) IEEE 802.15.4			
	TOQCB2-80-JR	Modbus-RTU			
	TOQCB2-80-JL	LTE Cat.1: LTE-FDD: B1/B3/B5/B8 LTE-TDD: B34/38/39/40/41 (2535~2655MHz) LTE-FDD: B1/B3/B5/B7/B8/B20/B28A* LTE-TDD: B38/40/41 GSM/GPRS: GSM900/DCS1800			
	TOQCB2-80-JM	TCP/UDP: Matter			
Energy Consumption Measurement Accuracy	Class 1.0				
Monitoring Physical Data	Real-time Voltage, Real-time Current, Real-time Power (Forward/Reverse), Power Factor, Power Consumption (Forward/Reverse), Temperature, Phase Angle, Switch State, Device Operating Status, Frequency				
Function Description	Multiple Timing, Over-voltage Protection, Under-voltage Protection, Over-current Protection, Over-Power Protection, Temperature protection, Short Circuit Protection, Auto-reclosing, Remote Control, Voice Control				
Mounting Support	DIN Rail 35mm				

TOQCB2-80 1P

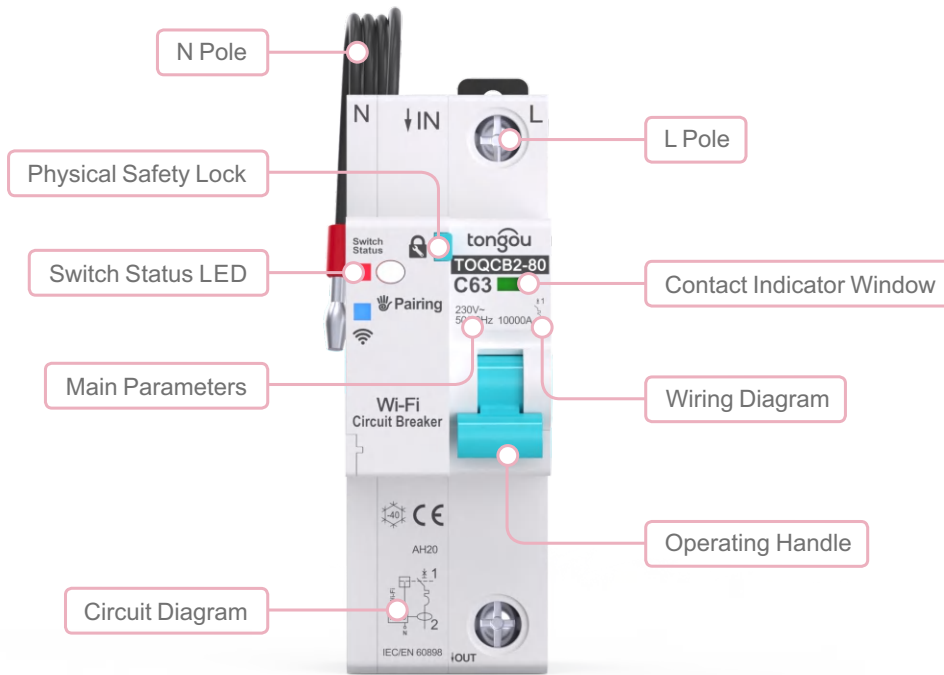

Connection

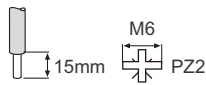
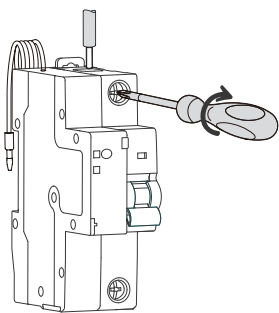

Rating	Tightening torque	Copper cables	
		Rigid	Flexible or ferrule
1 - 80A	2.5 N.m	1 - 25mm ²	1 - 16mm ²

Dimensions (mm)

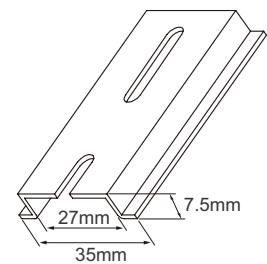
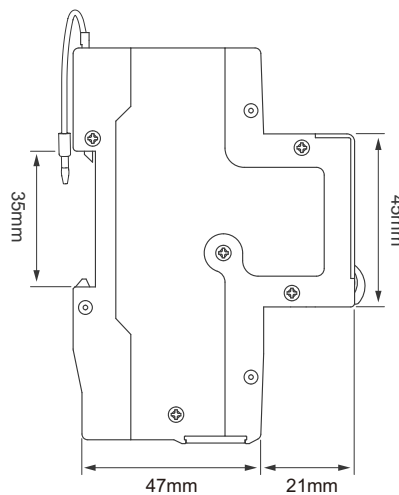
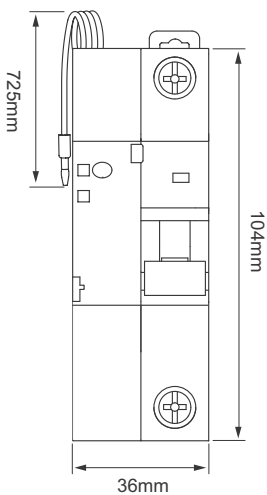

I TOQCB2-80 2P

⚡ Over-current Protection

Threshold Setting: 1 - 63A
 Default: 63A
 Status Setting: Off/Alarm/Trip
 Electronic Component Response Time: 3s

+⚡ Over-voltage Protection

Threshold Setting: 245V - 295A
 Default: 280V
 Status Setting: Off/Alarm/Trip
 Electronic Component Response Time: 3s

-⚡ Under-voltage Protection

Threshold Setting: 145V - 220A
 Default: 165V
 Status Setting: Off/Alarm/Trip
 Electronic Component Response Time: 3s

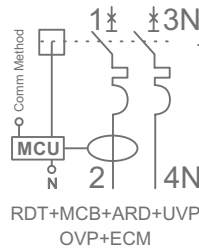

LED Indicator

- The switch Status LED steady blue, indicating that circuit breaker is disconnected.
- The switch Status LED steady red, indicating that circuit breaker is closed.
- The network LED flashing red slowly indicates that circuit breaker is in off-grid mode.
- The network LED flashing red quickly indicates that circuit breaker is in pairing mode.
- The network LED flashing blue slowly indicates that the circuit breaker is in the connected mode.

PRODUCT MODEL	TOQCB2-80-JW	TOQCB2-80-JZ	TOQCB2-80-JR	TOQCB2-80-JL	TOQCB2-80-JM
Standards	IEC/EN 60947, IEC/EN 60898, IEC/EN 50557, EN 301 489, EN 300 328, EN IEC 61000				
Poles Description	2P				
Operating Rated Voltage	Ue (V)	AC 145V - 230V			
Frequency	Hz	50/60Hz			
Current Frame	In (A)	16, 20, 32, 40, 63, 80			
Curve Code		B、C、D			
Rated Insulation Voltage	Ui (V)	AC 500V			
Rated Ultimate Short-circuit Breaking Capacity	Icu (kA)	10kA			
Short Circuit Protection	acc. to IEC/EN 60947-2, IEC/EN 60898-1				
Operational Safety	Physical Safety Lock, which prevents the device from being closed once engaged				
Communication Protocol	TOQCB2-80-JW	TCP/IP: Wi-Fi (2.412~2.484GHz) IEEE 802.11b/g/n			
	TOQCB2-80-JZ	Zigbee (2.400~2.483GHz) IEEE 802.15.4			
	TOQCB2-80-JR	Modbus-RTU			
	TOQCB2-80-JL	LTE Cat.1: LTE-FDD: B1/B3/B5/B8 LTE-TDD: B34/38/39/40/41 (2535~2655MHz) LTE-FDD: B1/B3/B5/B7/B8/B20/B28A* LTE-TDD: B38/40/41 GSM/GPRS: GSM900/DCS1800			
	TOQCB2-80-JM	TCP/UDP: Matter			
Energy Consumption Measurement Accuracy	Class 1.0				
Monitoring Physical Data	Real-time Voltage, Real-time Current, Real-time Power (Forward/Reverse), Power Factor, Power Consumption (Forward/Reverse), Temperature, Phase Angle, Switch State, Device Operating Status, Frequency				
Function Description	Multiple Timing, Over-voltage Protection, Under-voltage Protection, Over-current Protection, Over-Power Protection, Temperature protection, Short Circuit Protection, Auto-reclosing, Remote Control, Voice Control				
Mounting Support	DIN Rail 35mm				

TOQCB2-80 2P

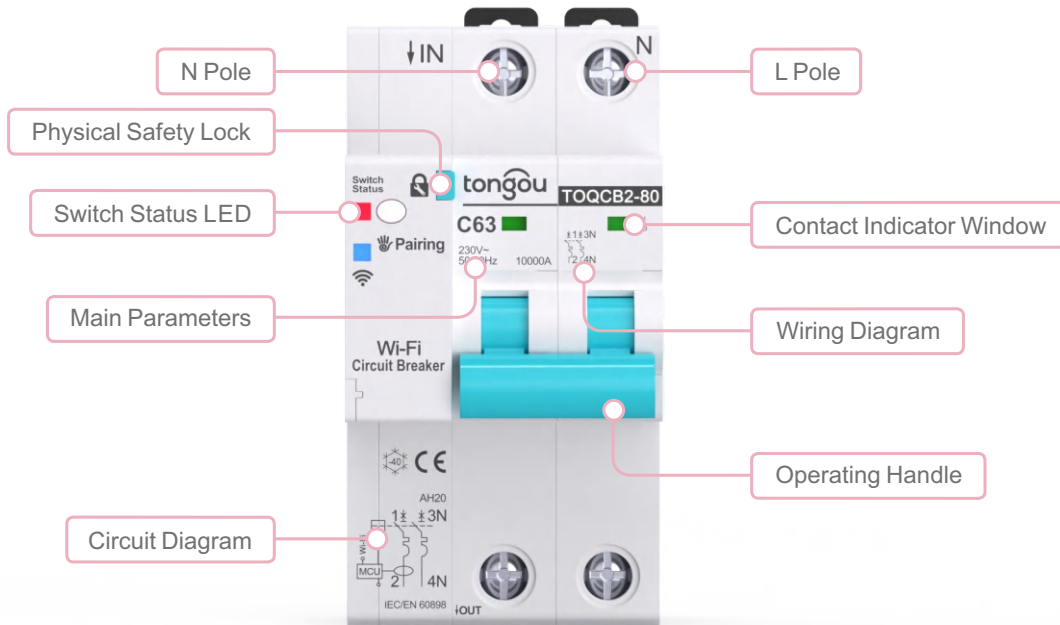

Connection

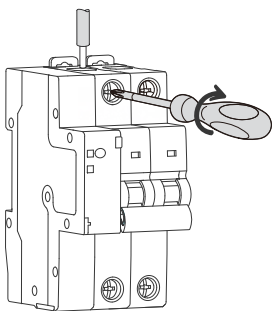

Rating	Tightening torque	Copper cables	
		Rigid	Flexible or ferrule
1 - 80A	2.5 N.m	1 - 25mm ²	1 - 16mm ²

Dimensions (mm)

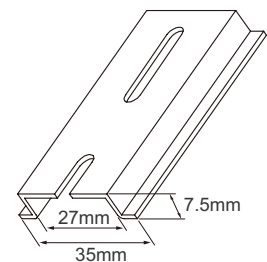
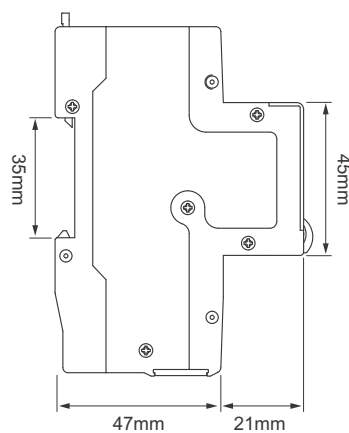
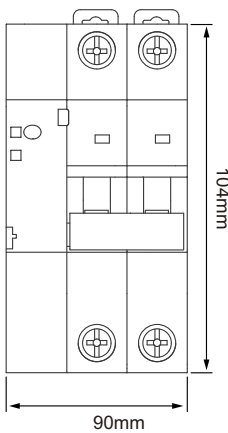

TOQCB2-80 3P

⚡ Over-current Protection

Threshold Setting: 1 - 63A
 Default: 63A
 Status Setting: Off/Alarm/Trip
 Electronic Component Response Time: 3s

+⚡ Over-voltage Protection

Threshold Setting: 245V - 295A
 Default: 280V
 Status Setting: Off/Alarm/Trip
 Electronic Component Response Time: 3s

-⚡ Under-voltage Protection

Threshold Setting: 145V - 220A
 Default: 165V
 Status Setting: Off/Alarm/Trip
 Electronic Component Response Time: 3s

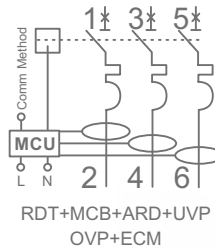

LED Indicator

- The switch Status LED steady blue, indicating that circuit breaker is disconnected.
- The switch Status LED steady red, indicating that circuit breaker is closed.
- The network LED flashing red slowly indicates that circuit breaker is in off-grid mode.
- The network LED flashing red quickly indicates that circuit breaker is in pairing mode.
- The network LED flashing blue slowly indicates that the circuit breaker is in the connected mode.

PRODUCT MODEL	TOQCB2-80-JW	TOQCB2-80-JZ	TOQCB2-80-JR	TOQCB2-80-JL	TOQCB2-80-JM
Standards	IEC/EN 60947, IEC/EN 60898, IEC/EN 50557, EN 301 489, EN 300 328, EN IEC 61000				
Poles Description	3P				
MCU Power Rated Operational Voltage U _e (V)	AC 380V - 415V				
Phase Line Operational Voltage U _e (V)	AC 230V(L1-N, L2-N, L3-N)				
Frequency Hz	50/60Hz				
Current Frame I _n (A)	16, 20, 32, 40, 63, 80				
Curve Code	B, C, D				
Rated Insulation Voltage U _i (V)	AC 500V				
Rated Ultimate Short-circuit Breaking Capacity I _{cu} (kA)	10kA				
Short Circuit Protection	acc. to IEC/EN 60947-2, IEC/EN 60898-1				
Operational Safety	Physical Safety Lock, which prevents the device from being closed once engaged				
Communication Protocol	TOQCB2-80-JW	TCP/IP: Wi-Fi (2.412~2.484GHz) IEEE 802.11b/g/n			
	TOQCB2-80-JZ	Zigbee (2.400~2.483GHz) IEEE 802.15.4			
	TOQCB2-80-JR	Modbus-RTU			
	TOQCB2-80-JL	LTE Cat.1: LTE-FDD: B1/B3/B5/B8 LTE-TDD: B34/38/39/40/41 (2535~2655MHz) LTE-FDD: B1/B3/B5/B7/B8/B20/B28A* LTE-TDD: B38/40/41 GSM/GPRS: GSM900/DCS1800			
	TOQCB2-80-JM	TCP/UDP: Matter			
Energy Consumption Measurement Accuracy	Class 1.0				
Monitoring Physical Data	Real-time Voltage, Real-time Current, Real-time Power (Forward/Reverse), Power Factor, Power Consumption (Forward/Reverse), Temperature, Phase Angle, Switch State, Device Operating Status, Frequency				
Function Description	Multiple Timing, Over-voltage Protection, Under-voltage Protection, Over-current Protection, Over-Power Protection, Temperature protection, Short Circuit Protection, Auto-reclosing, Remote Control, Voice Control				
Mounting Support	DIN Rail 35mm				

TOQCB2-80 3P

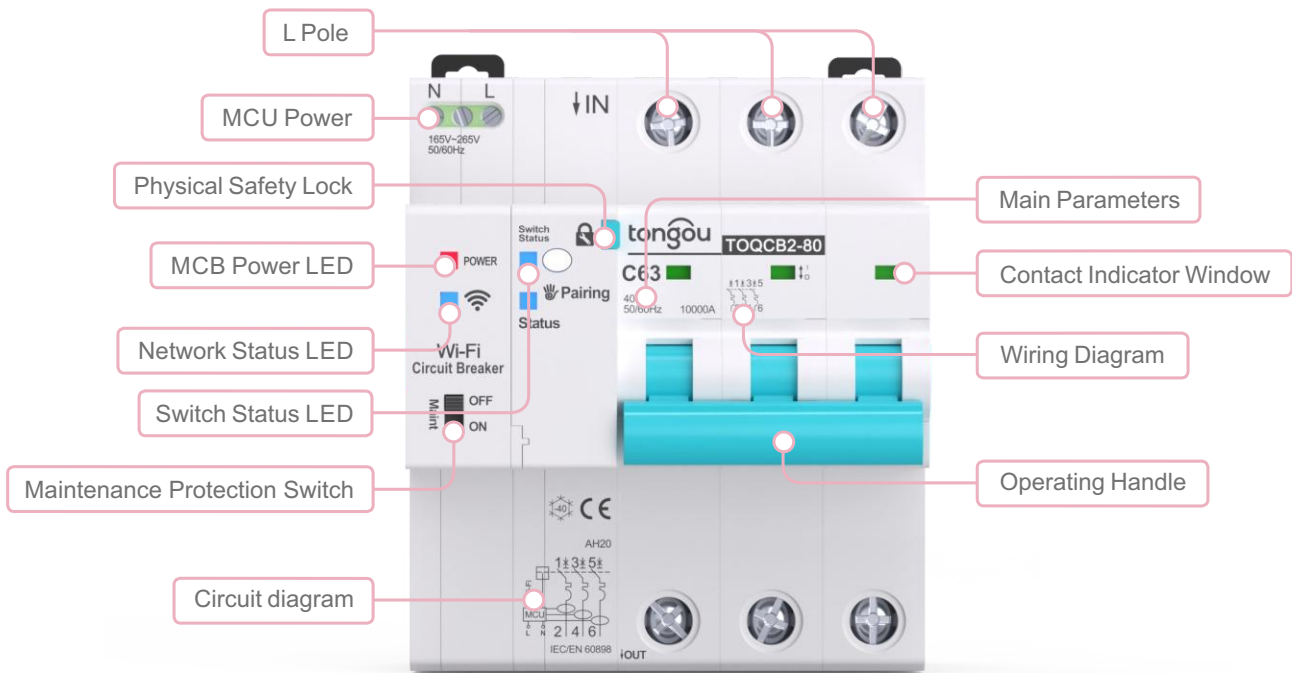

Connection

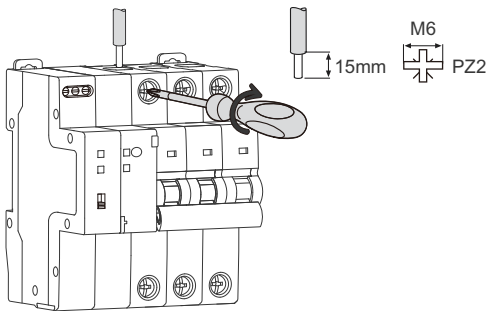

Rating	Tightening torque	Copper cables	
		Rigid	Flexible or ferrule
1 - 80A	2.5 N.m	1 - 25mm ²	1 - 16mm ²

Dimensions (mm)

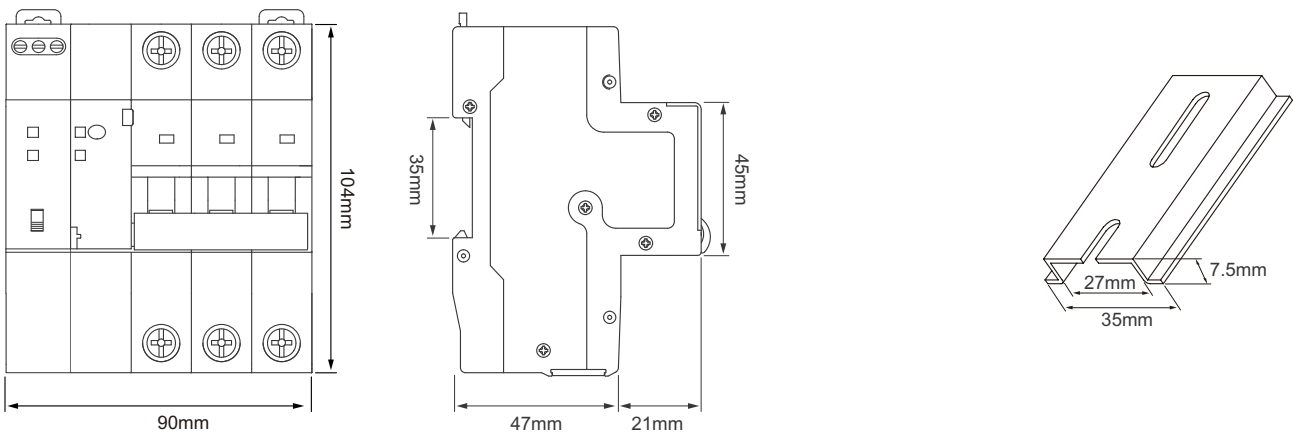

I TOQCB2-80 4P

⚡ Over-current Protection

Threshold Setting: 1 - 63A
 Default: 63A
 Status Setting: Off/Alarm/Trip
 Electronic Component Response Time: 3s

+⚡ Over-voltage Protection

Threshold Setting: 245V - 295A
 Default: 280V
 Status Setting: Off/Alarm/Trip
 Electronic Component Response Time: 3s

-⚡ Under-voltage Protection

Threshold Setting: 145V - 220A
 Default: 165V
 Status Setting: Off/Alarm/Trip
 Electronic Component Response Time: 3s

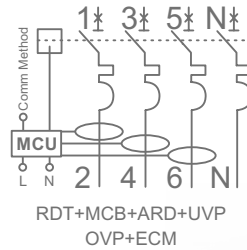

LED Indicator

- The switch Status LED steady blue, indicating that circuit breaker is disconnected.
- The switch Status LED steady red, indicating that circuit breaker is closed.
- The network LED flashing red slowly indicates that circuit breaker is in off-grid mode.
- The network LED flashing red quickly indicates that circuit breaker is in pairing mode.
- The network LED flashing blue slowly indicates that the circuit breaker is in the connected mode.

PRODUCT MODEL	TOQCB2-80-JW	TOQCB2-80-JZ	TOQCB2-80-JR	TOQCB2-80-JL	TOQCB2-80-JM
Standards	IEC/EN 60947, IEC/EN 60898, IEC/EN 50557, EN 301 489, EN 300 328, EN IEC 61000				
Poles Description	4P				
MCU Power Rated Operational Voltage U _e (V)	AC 380V - 415V				
Phase Line Operational Voltage U _e (V)	AC 230V(L1-N, L2-N, L3-N)				
Frequency Hz	50/60Hz				
Current Frame I _n (A)	16, 20, 32, 40, 63, 80				
Curve Code	B, C, D				
Rated Insulation Voltage U _i (V)	AC 500V				
Rated Ultimate Short-circuit Breaking Capacity I _{cu} (kA)	10kA				
Short Circuit Protection	acc. to IEC/EN 60947-2, IEC/EN 60898-1				
Operational Safety	Physical Safety Lock, which prevents the device from being closed once engaged				
Communication Protocol	TOQCB2-80-JW	TCP/IP: Wi-Fi (2.412~2.484GHz) IEEE 802.11b/g/n			
	TOQCB2-80-JZ	Zigbee (2.400~2.483GHz) IEEE 802.15.4			
	TOQCB2-80-JR	Modbus-RTU			
	TOQCB2-80-JL	LTE Cat.1: LTE-FDD: B1/B3/B5/B8 LTE-TDD: B34/38/39/40/41 (2535~2655MHz) LTE-FDD: B1/B3/B5/B7/B8/B20/B28A* LTE-TDD: B38/40/41 GSM/GPRS: GSM900/DCS1800			
	TOQCB2-80-JM	TCP/UDP: Matter			
Energy Consumption Measurement Accuracy	Class 1.0				
Monitoring Physical Data	Real-time Voltage, Real-time Current, Real-time Power (Forward/Reverse), Power Factor, Power Consumption (Forward/Reverse), Temperature, Phase Angle, Switch State, Device Operating Status, Frequency				
Function Description	Multiple Timing, Over-voltage Protection, Under-voltage Protection, Over-current Protection, Over-Power Protection, Temperature protection, Short Circuit Protection, Auto-reclosing, Remote Control, Voice Control				
Mounting Support	DIN Rail 35mm				

I TOQCB2-80 4P

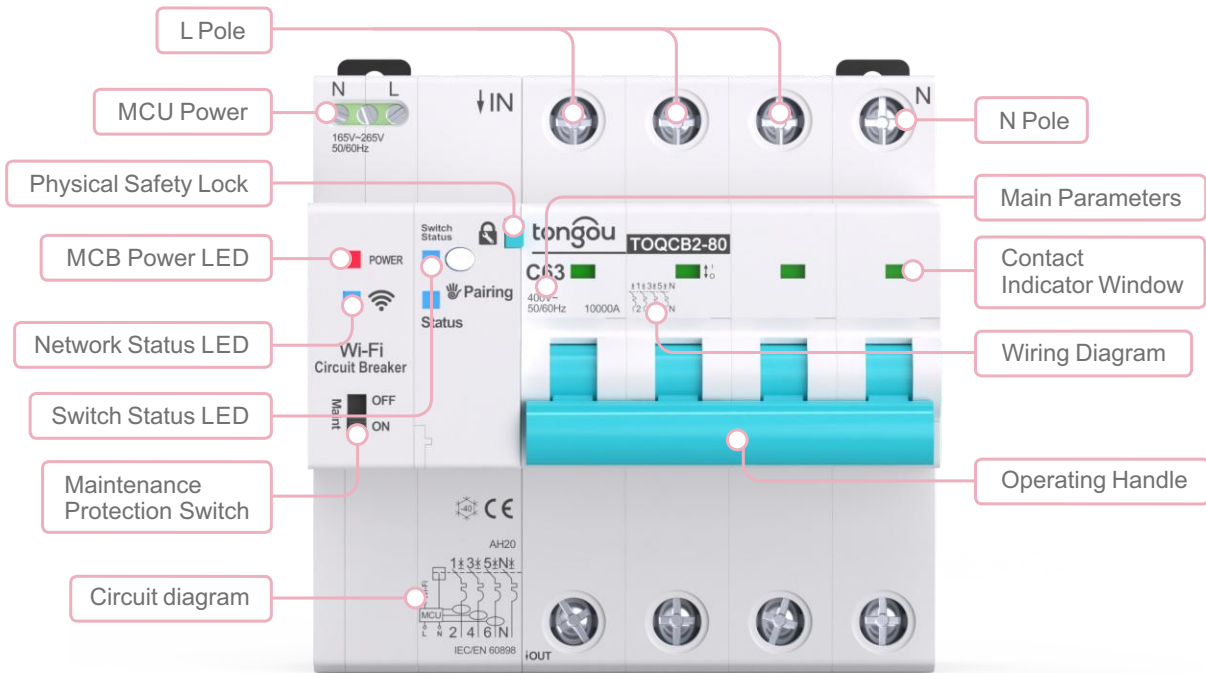

Connection

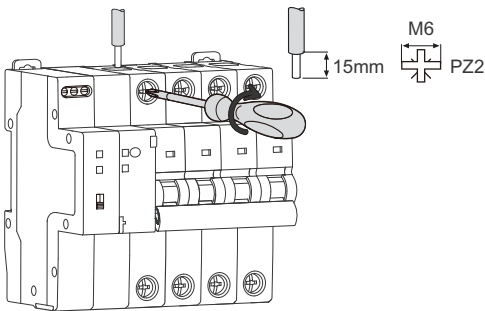

Rating	Tightening torque	Copper cables	
		Rigid	Flexible or ferrule
1 - 80A	2.5 N.m	1 - 25mm ²	1 - 16mm ²

Dimensions (mm)

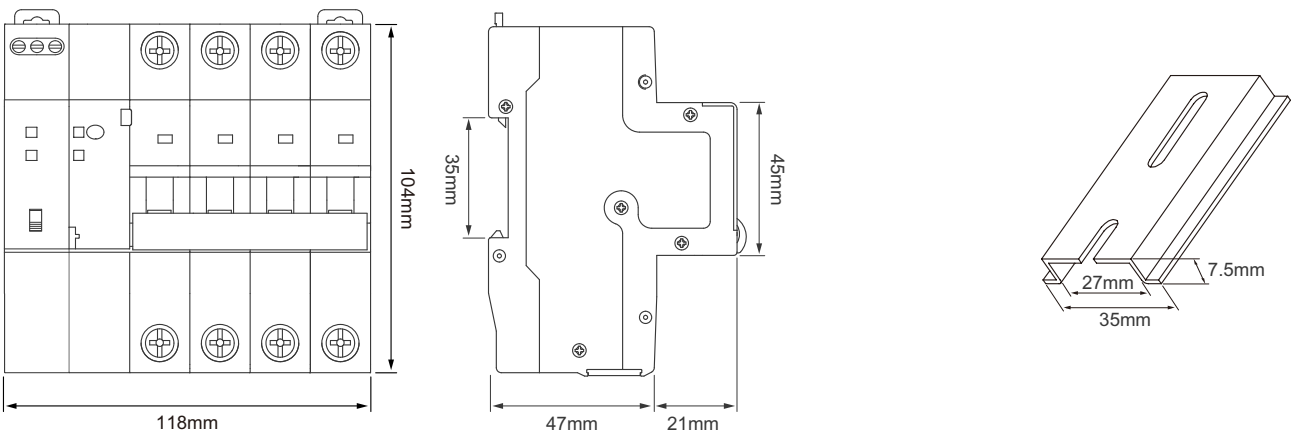

Smart Circuit Breaker TOQCB2L Series

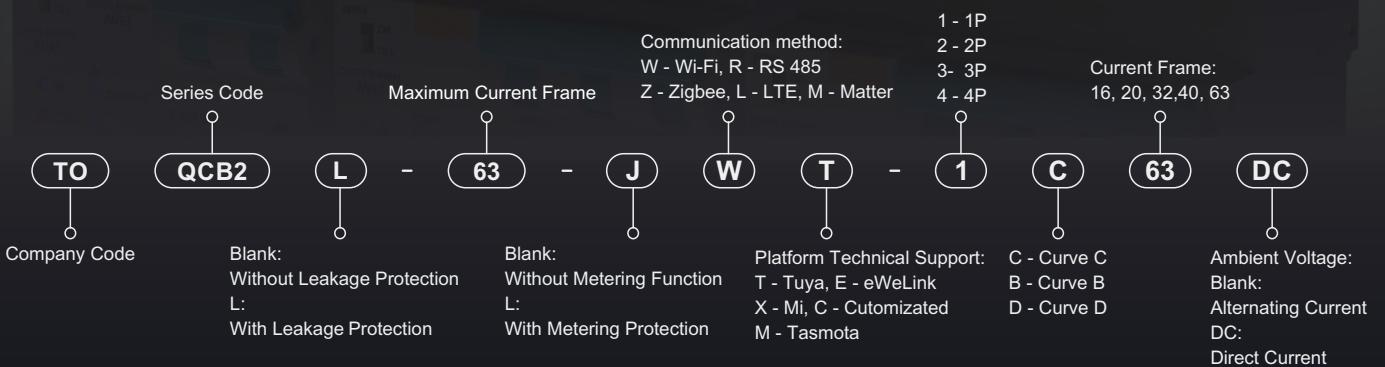

Smart Circuit Breaker **TOQCB2L Series**

Tongou envisions a future of smart electricity consumption, ensuring safety, efficiency, and seamless integration with intelligent automation systems through advanced electrical protection, leakage protection, efficient energy management, and streamlined power maintenance.



Remote Control



Voice Control



Time Mode



Circuit Protection



Electricity Consumption



Real-Time Power / Current / Voltage



Temperature Protection



Operation Log



DIN Rail Installation



Maintenance Mode



Leakage Protection

TOQCB2L-63 2P

⚡ Over-current Protection

Threshold Setting: 1 - 63A
 Default: 63A
 Status Setting: Off/Alarm/Trip
 Electronic Component Response Time: 3s

+⚡ Over-voltage Protection

Threshold Setting: 245V - 295A
 Default: 280V
 Status Setting: Off/Alarm/Trip
 Electronic Component Response Time: 3s

-⚡ Under-voltage Protection

Threshold Setting: 145V - 220A
 Default: 165V
 Status Setting: Off/Alarm/Trip
 Electronic Component Response Time: 3s

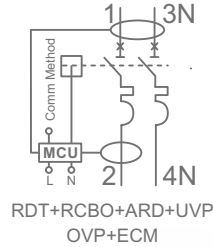

LED Indicator

- The switch Status LED steady blue, indicating that circuit breaker is disconnected.
- The switch Status LED steady red, indicating that circuit breaker is closed.
- The network LED flashing red slowly indicates that circuit breaker is in off-grid mode.
- The network LED flashing red quickly indicates that circuit breaker is in pairing mode.
- The network LED flashing blue slowly indicates that the circuit breaker is in the connected mode.

PRODUCT MODEL	TOQCB2L-63-JW	TOQCB2L-63-JZ	TOQCB2L-63-JR	TOQCB2L-63-JL	TOQCB2L-63-JM
Standards	IEC/EN 61009, IEC/EN 50557, EN 301 489, EN 300 328, EN IEC 61000				
Poles Description	2P				
MCU Power Rated Operational Voltage	Ue (V) AC 145V - 230V				
Phase Line Operational Voltage	Ue (V) AC 230V				
Frequency	Hz 50/60Hz				
Current Frame	In (A) 16, 20, 32, 40, 63				
Rated Residual Operating Current	Idn (mA) 30, 100, 300, 500				
Residual Current Type	AC, A				
Curve Code	B, C, D				
Rated Insulation Voltage	Ui (V) AC 500V				
Rated Ultimate Short-circuit Breaking Capacity	Icu (kA) 10kA				
Short Circuit Protection	acc. to IEC/EN 60947-2, IEC/EN 60898-1				
Operational Safety	Physical Safety Lock, which prevents the device from being closed once engaged				
Communication Protocol	TOQCB2L-63-JW	TCP/IP: Wi-Fi (2.412~2.484GHz) IEEE 802.11b/g/n			
	TOQCB2L-63-JZ	Zigbee (2.400~2.483GHz) IEEE 802.15.4			
	TOQCB2L-63-JR	Modbus-RTU			
	TOQCB2L-63-JL	LTE Cat.1: LTE-FDD: B1/B3/B5/B8 LTE-TDD: B34/38/39/40/41 (2535~2655MHz) LTE-FDD: B1/B3/B5/B7/B8/B20/B28A* LTE-TDD: B38/40/41 GSM/GPRS: GSM900/DCS1800			
	TOQCB2L-63-JM	TCP/UDP: Matter			
Energy Consumption Measurement Accuracy	Class 1.0				
Monitoring Physical Data	Real-time Voltage, Real-time Current, Real-time Power (Forward/Reverse), Power Factor, Power Consumption (Forward/Reverse), Temperature, Phase Angle, Switch State, Device Operating Status, Frequency				
Function Description	Multiple Timing, Over-voltage Protection, Under-voltage Protection, Over-current Protection, Over-Power Protection, Temperature protection, Short Circuit Protection, Auto-reclosing, Remote Control, Voice Control				
Mounting Support	DIN Rail 35mm				

TOQCB2L-63 2P

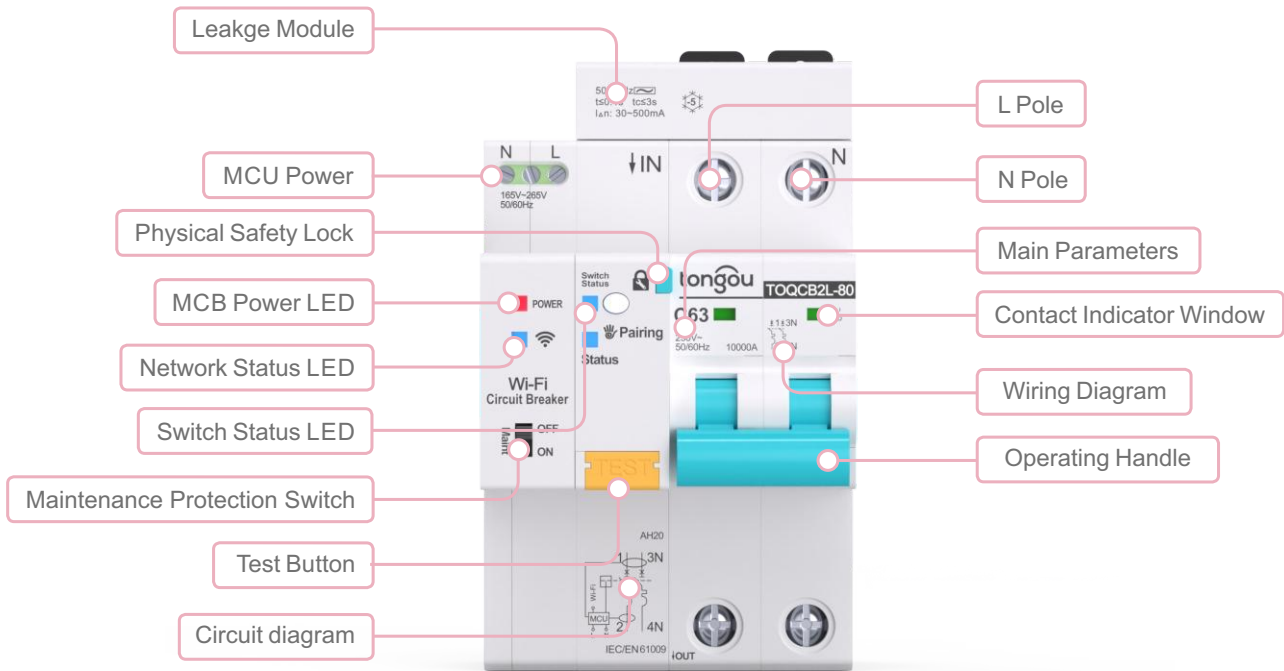

Connection

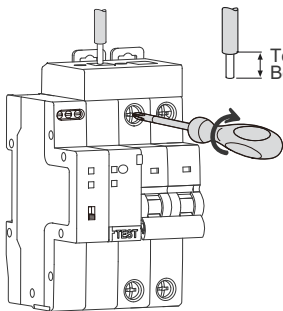

Rating	Tightening torque	Copper cables	
		Rigid	Flexible or ferrule
1 - 40A	2.5 N.m	1 - 10mm ²	1 - 6mm ²
50 - 63A	2.5 N.m	16 - 25mm ²	1 - 16mm ²

Dimensions (mm)

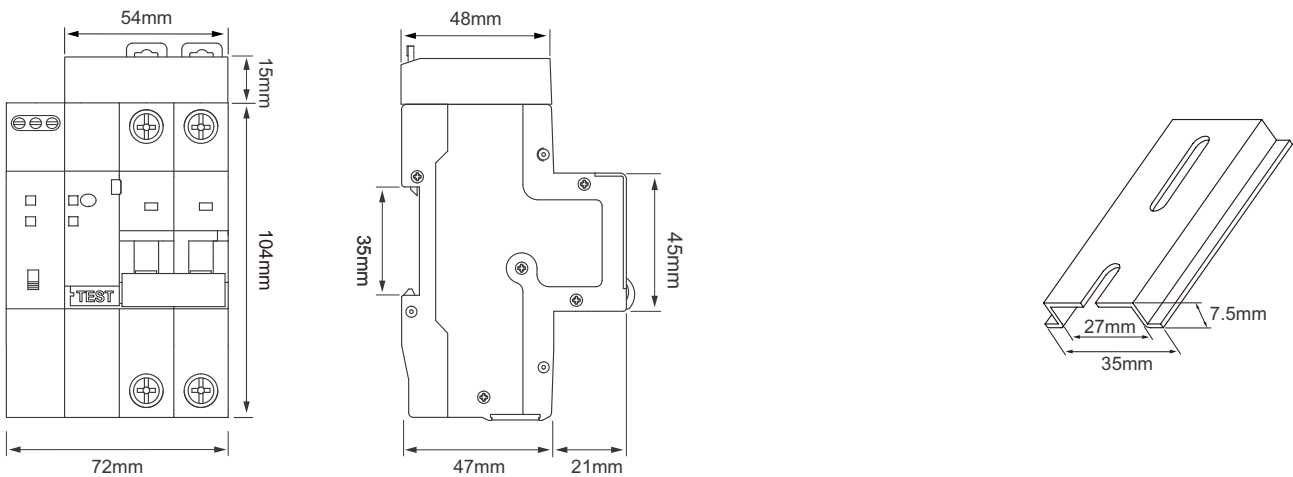

TOQCB2L-63 3P

Over-current Protection

Threshold Setting: 1 - 63A
 Default: 63A
 Status Setting: Off/Alarm/Trip
 Electronic Component Response Time: 3s

Over-voltage Protection

Threshold Setting: 245V - 295A
 Default: 280V
 Status Setting: Off/Alarm/Trip
 Electronic Component Response Time: 3s

Under-voltage Protection

Threshold Setting: 145V - 220A
 Default: 165V
 Status Setting: Off/Alarm/Trip
 Electronic Component Response Time: 3s

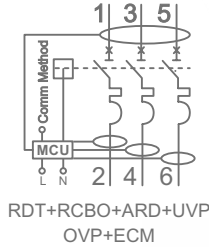

LED Indicator

- The switch Status LED steady blue, indicating that circuit breaker is disconnected.
- The switch Status LED steady red, indicating that circuit breaker is closed.
- The network LED flashing red slowly indicates that circuit breaker is in off-grid mode.
- The network LED flashing red quickly indicates that circuit breaker is in pairing mode.
- The network LED flashing blue slowly indicates that the circuit breaker is in the connected mode.

PRODUCT MODEL	TOQCB2L-63-JW	TOQCB2L-63-JZ	TOQCB2L-63-JR	TOQCB2L-63-JL	TOQCB2L-63-JM
Standards	IEC/EN 61009, IEC/EN 50557, EN 301 489, EN 300 328, EN IEC 61000				
Poles Description	3P				
MCU Power Rated Operational Voltage U _e (V)	AC 145V - 230V				
Phase Line Operational Voltage U _e (V)	AC 230V (L1-N, L2-N, L3-N)				
Frequency Hz	50/60Hz				
Current Frame I _n (A)	16, 20, 32, 40, 63				
Rated Residual Operating Current I _{Δn} (mA)	30, 100, 300, 500				
Residual Current Type	AC, A				
Curve Code	B, C, D				
Rated Insulation Voltage U _i (V)	AC 500V				
Rated Ultimate Short-circuit Breaking Capacity I _{cu} (kA)	10kA				
Short Circuit Protection	acc. to IEC/EN 60947-2, IEC/EN 60898-1				
Operational Safety	Physical Safety Lock, which prevents the device from being closed once engaged				
Communication Protocol	TOQCB2L-63-JW	TCP/IP: Wi-Fi (2.412~2.484GHz) IEEE 802.11b/g/n			
	TOQCB2L-63-JZ	Zigbee (2.400~2.483GHz) IEEE 802.15.4			
	TOQCB2L-63-JR	Modbus-RTU			
	TOQCB2L-63-JL	LTE Cat.1: LTE-FDD: B1/B3/B5/B8 LTE-TDD: B34/38/39/40/41 (2535~2655MHz) LTE-FDD: B1/B3/B5/B7/B8/B20/B28A* LTE-TDD: B38/40/41 GSM/GPRS: GSM900/DCS1800			
	TOQCB2L-63-JM	TCP/UDP: Matter			
Energy Consumption Measurement Accuracy	Class 1.0				
Monitoring Physical Data	Real-time Voltage, Real-time Current, Real-time Power (Forward/Reverse), Power Factor, Power Consumption (Forward/Reverse), Temperature, Phase Angle, Switch State, Device Operating Status, Frequency				
Function Description	Multiple Timing, Over-voltage Protection, Under-voltage Protection, Over-current Protection, Over-Power Protection, Temperature protection, Short Circuit Protection, Auto-reclosing, Remote Control, Voice Control				
Mounting Support	DIN Rail 35mm				

TOQCB2L-63 3P

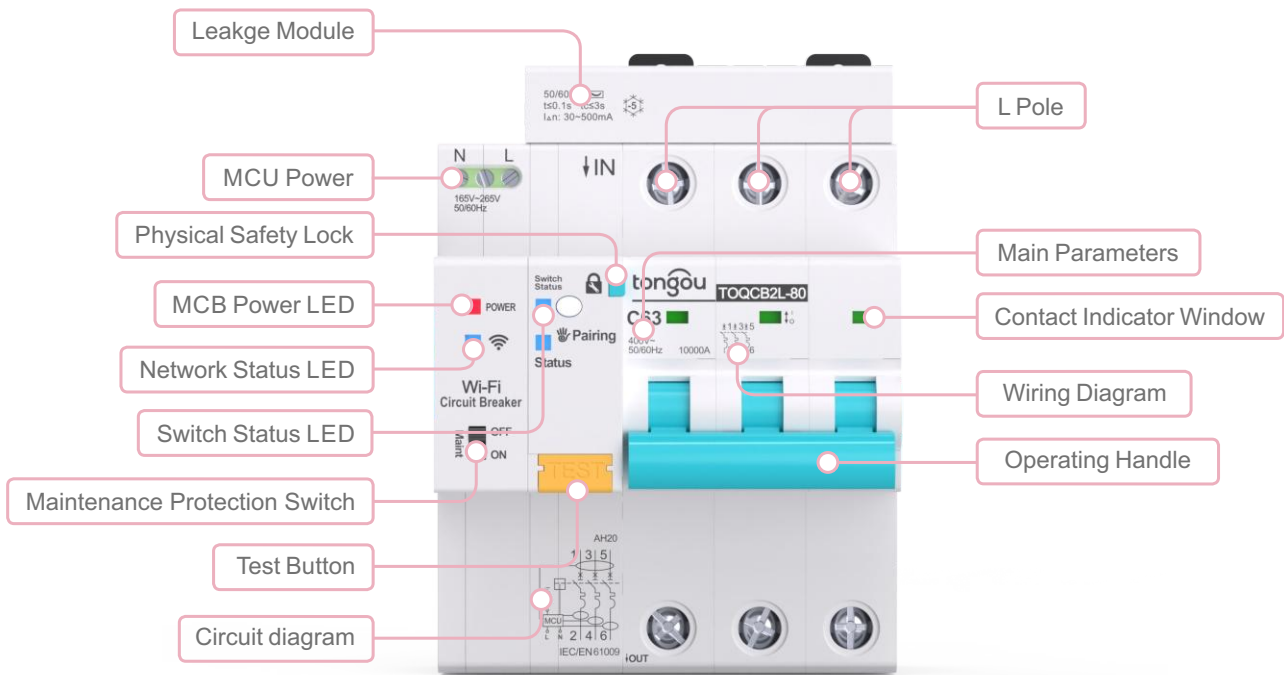

Connection

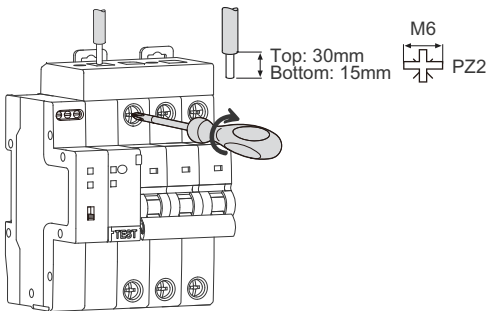

Rating	Tightening torque	Copper cables	
		Rigid	Flexible or ferrule
1 - 40A	2.5 N.m	1 - 10mm ²	1 - 6mm ²
50 - 63A	2.5 N.m	16 - 25mm ²	1 - 16mm ²

Dimensions (mm)

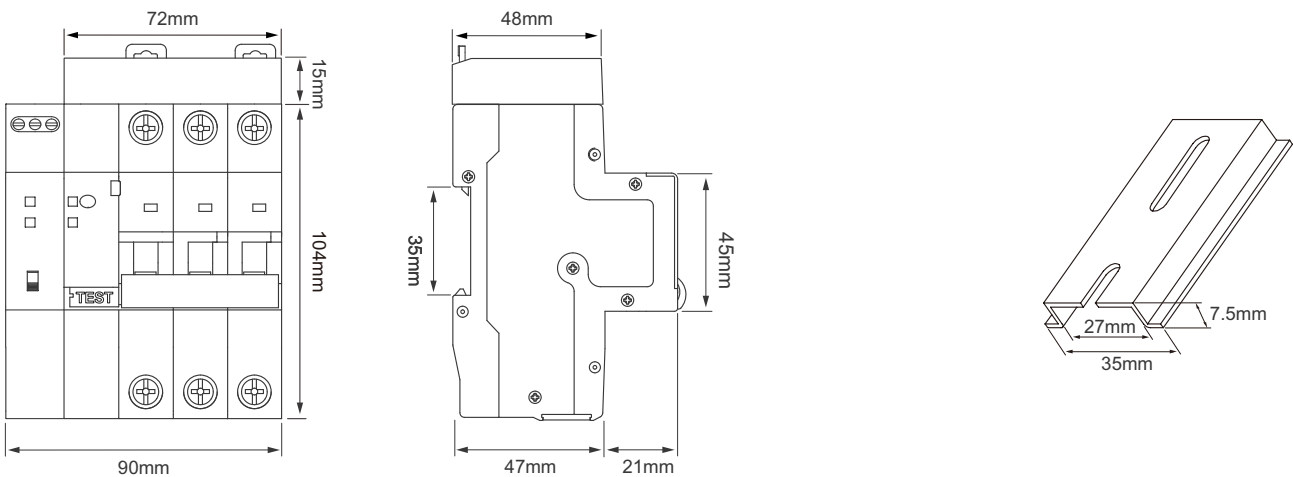

TOQCB2L-63 4P

Over-current Protection

Threshold Setting: 1 - 63A
 Default: 63A
 Status Setting: Off/Alarm/Trip
 Electronic Component Response Time: 3s

Over-voltage Protection

Threshold Setting: 245V - 295A
 Default: 280V
 Status Setting: Off/Alarm/Trip
 Electronic Component Response Time: 3s

Under-voltage Protection

Threshold Setting: 145V - 220A
 Default: 165V
 Status Setting: Off/Alarm/Trip
 Electronic Component Response Time: 3s

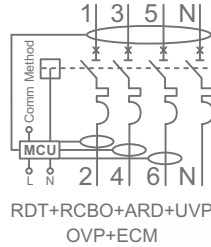

LED Indicator

- The switch Status LED steady blue, indicating that circuit breaker is disconnected.
- The switch Status LED steady red, indicating that circuit breaker is closed.
- The network LED flashing red slowly indicates that circuit breaker is in off-grid mode.
- The network LED flashing red quickly indicates that circuit breaker is in pairing mode.
- The network LED flashing blue slowly indicates that the circuit breaker is in the connected mode.

PRODUCT MODEL	TOQCB2L-63-JW	TOQCB2L-63-JZ	TOQCB2L-63-JR	TOQCB2L-63-JL	TOQCB2L-63-JM
Standards	IEC/EN 61009, IEC/EN 50557, EN 301 489, EN 300 328, EN IEC 61000				
Poles Description	4P				
MCU Power Rated Operational Voltage U _e (V)	AC 145V - 230V				
Phase Line Operational Voltage U _e (V)	AC 230V (L1-N, L2-N, L3-N)				
Frequency Hz	50/60Hz				
Current Frame I _n (A)	16, 20, 32, 40, 63				
Rated Residual Operating Current I _{Δn} (mA)	30, 100, 300, 500				
Residual Current Type	AC, A				
Curve Code	B, C, D				
Rated Insulation Voltage U _i (V)	AC 500V				
Rated Ultimate Short-circuit Breaking Capacity I _{cu} (kA)	10kA				
Short Circuit Protection	acc. to IEC/EN 60947-2, IEC/EN 60898-1				
Operational Safety	Physical Safety Lock, which prevents the device from being closed once engaged				
Communication Protocol	TOQCB2L-63-JW	TCP/IP: Wi-Fi (2.412~2.484GHz) IEEE 802.11b/g/n			
	TOQCB2L-63-JZ	Zigbee (2.400~2.483GHz) IEEE 802.15.4			
	TOQCB2L-63-JR	Modbus-RTU			
	TOQCB2L-63-JL	LTE Cat.1: LTE-FDD: B1/B3/B5/B8 LTE-TDD: B34/38/39/40/41 (2535~2655MHz) LTE-FDD: B1/B3/B5/B7/B8/B20/B28A* LTE-TDD: B38/40/41 GSM/GPRS: GSM900/DCS1800			
	TOQCB2L-63-JM	TCP/UDP: Matter			
Energy Consumption Measurement Accuracy	Class 1.0				
Monitoring Physical Data	Real-time Voltage, Real-time Current, Real-time Power (Forward/Reverse), Power Factor, Power Consumption (Forward/Reverse), Temperature, Phase Angle, Switch State, Device Operating Status, Frequency				
Function Description	Multiple Timing, Over-voltage Protection, Under-voltage Protection, Over-current Protection, Over-Power Protection, Temperature protection, Short Circuit Protection, Auto-reclosing, Remote Control, Voice Control				
Mounting Support	DIN Rail 35mm				

I TOQCB2L-63 4P

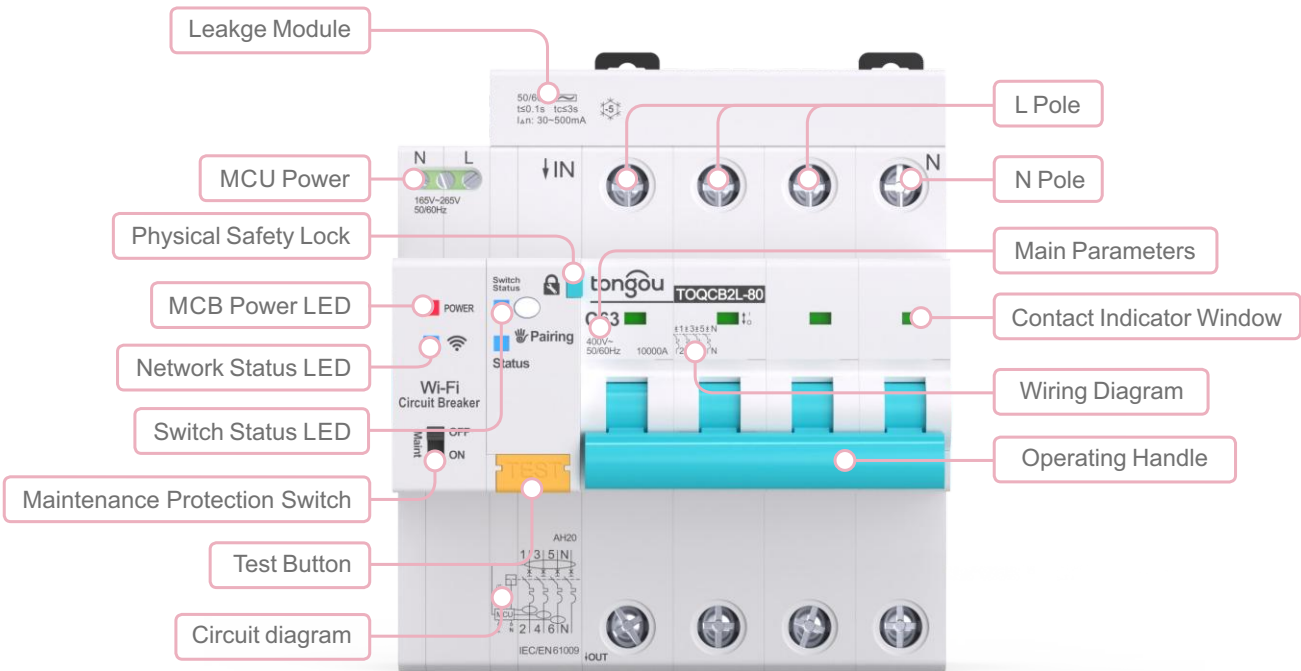

Connection

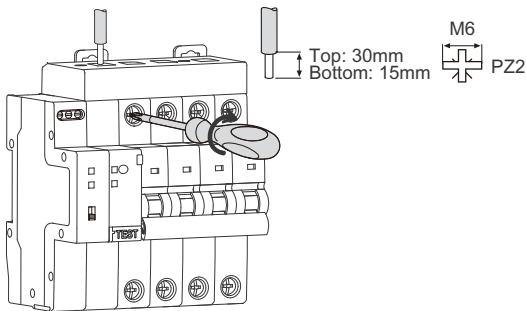

Rating	Tightening torque	Copper cables	
		Rigid	Flexible or ferrule
1 - 40A	2.5 N.m	1 - 10mm ²	1 - 6mm ²
50 - 63A	2.5 N.m	16 - 25mm ²	1 - 16mm ²

Dimensions (mm)

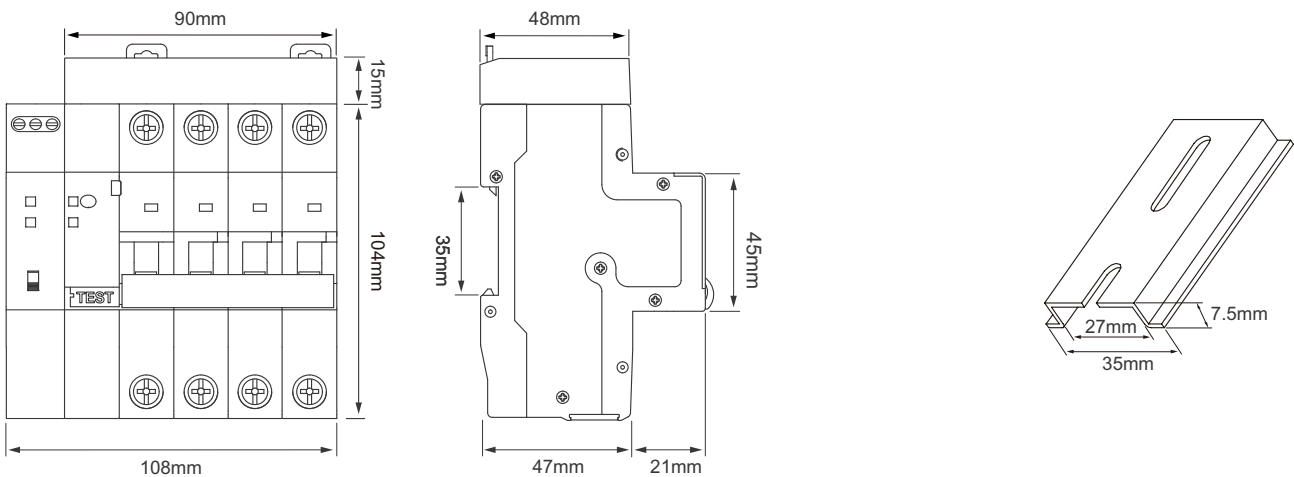

Smart Circuit Breaker TOSMR1 Series



Company Code

TO

Maximum Current Frame

40

Communication method:

W - Wi-Fi, R - RS 485
Z - Zigbee, L - LTEM - Matter

C - Curve C
B - Curve B

Ambient Voltage:

Blank:
Alternating Current
DC:
Direct Current

SMR1

Series Code

J

Blank:
Without Metering Function
L:
With Metering Function

W

Platform Technical Support:
T - Tuya, E - eWeLink
X - Mi, C - Customized
M - Tasmota

T

C

40

Current Frame:
16, 20, 32, 40

DC

Smart Circuit Breaker TOSMR1 Series

TOSMR1 series upgrades your energy management, gracefully replacing traditional DPN RCBO product with a smart formfactor. This product range not only saves space but also integrates intelligent control and energy monitoring functions, offering comprehensive protection against leakage, over-voltage and under-voltage. Its advanced design ensures efficient and reliable electrical safety, regardless of space size or installation distance.



Remote Control



Voice Control



Time Mode



Circuit Protection



Electricity Consumption



Real-Time Power / Current / Voltage



Temperature Protection



Operation Log



DIN Rail Installation



Maintenance Mode



Leakage Protection

TOSMR1-40

⚡ Over-current Protection

Threshold Setting:

TOSMR1-40: 20 - 40A Default: 40A

TOSMR1-20: 1 - 40A Default: 20A

Status Setting: Off/Alarm/Trip

Electronic Component Response Time: 3s

+⚡ Over-voltage Protection

Threshold Setting: 245V - 295A

Default: 280V

Status Setting: Off/Alarm/Trip

Electronic Component Response Time: 3s

-⚡ Under-voltage Protection

Threshold Setting: 145V - 220A





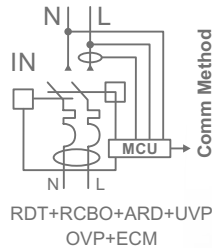

Default: 165V

Status Setting: Off/Alarm/Trip

Electronic Component Response Time: 3s



LED Indicator

-  The LED indicator shows a steady blue light to indicate that the device is disconnected.
-  The LED indicator shows a steady red light to indicate that the device is connected.
-  The LED indicator shows red and blue lights alternately flashing slowly, indicating that the device is configured but not connected to the router.
-  The LED indicator shows red and blue lights alternately flashing quickly, indicating that the device has lost configuration.
-  The LED indicator shows red light flashing slowly to indicate the initial state.
-  The LED indicator shows red light flashing quickly to indicate the status of the network pairing.

PRODUCT MODEL	TOSMR1-40-JW	TOSMR1-40-JZ	TOSMR1-40-JR	TOSMR1-40-JL	TOSMR1-40-JM
Standards	IEC/EN 61009, IEC/EN 50557, EN 301 489, EN 300 328, EN IEC 61000				
Poles Description	2P				
MCU Power Rated Operational Voltage U _e (V)	AC 145V - 230V				
Phase Line Operational Voltage U _e (V)	AC 230V				
Frequency Hz	50/60Hz				
Current Frame I _n (A)	16, 20, 32, 40				
Rated Residual Operating Current I _{Δn} (mA)	10, 30, 100				
Residual Current Type	AC, A				
Curve Code	B, C, D				
Rated Insulation Voltage U _i (V)	AC 500V				
Rated Ultimate Short-circuit Breaking Capacity I _{cu} (kA)	6kA				
Operational Safety	Physical Safety Lock, which prevents the device from being closed once engaged				
Communication Protocol	TOSMR1-40-JW	TCP/IP: Wi-Fi (2.412~2.484GHz) IEEE 802.11b/g/n			
	TOSMR1-40-JZ	Zigbee (2.400~2.483GHz) IEEE 802.15.4			
	TOSMR1-40-JR	Modbus-RTU			
	TOSMR1-40-JL	LTE Cat.1: LTE-FDD: B1/B3/B5/B8 LTE-TDD: B34/38/39/40/41 (2535~2655MHz) LTE-FDD: B1/B3/B5/B7/B8/B20/B28A* LTE-TDD: B38/40/41 GSM/GPRS: GSM900/DCS1800			
	TOSMR1-40-JM	TCP/UDP: Matter			
Energy Consumption Measurement Accuracy	Class 1.0				
Monitoring Physical Data	Real-time Voltage, Real-time Current, Real-time Power (Forward/Reverse), Power Factor, Power Consumption (Forward/Reverse), Temperature, Switch State, Device Operating Status, Frequency				
Function Description	Multiple Timing, Over-voltage Protection, Under-voltage Protection, Over-current Protection, Over-Power Protection, Temperature protection, Short Circuit Protection, Earth Leakage Protection, Auto-reclosing, Remote Control, Voice Control				

I TOSMR1-40

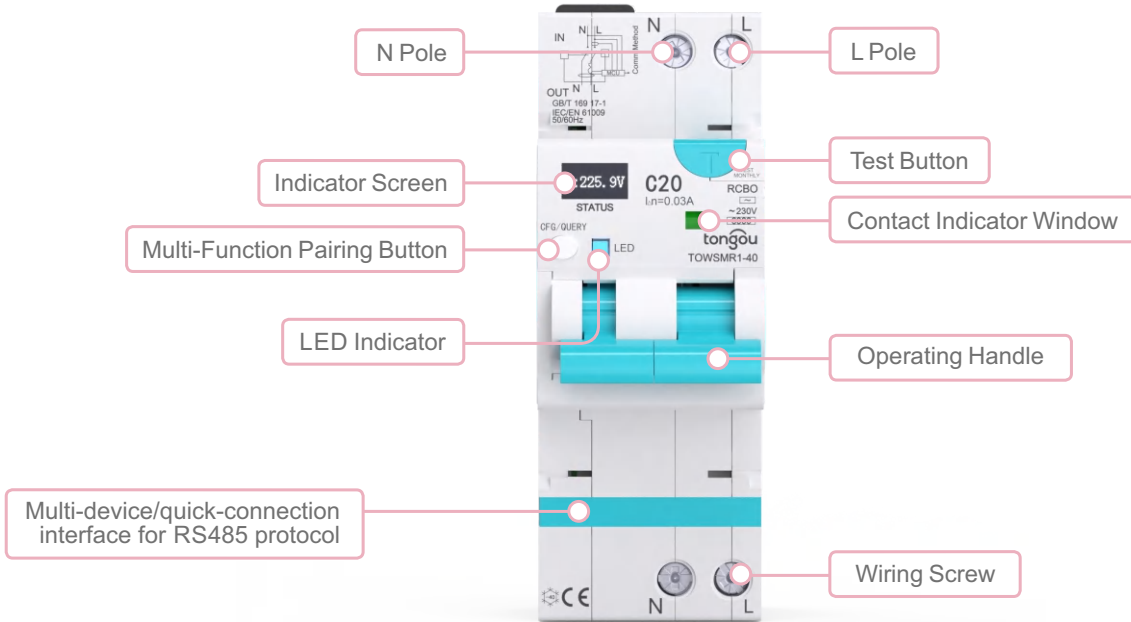

Connection

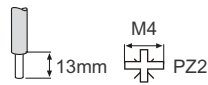
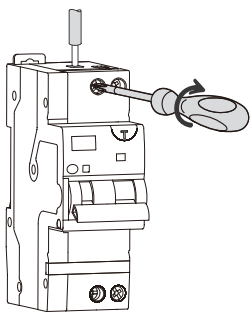

Rating	Tightening torque	Copper cables	
		Rigid	Flexible or ferrule
1 - 40A	1.8 N.m	1 - 10mm ²	1 - 6mm ²

Dimensions (mm)

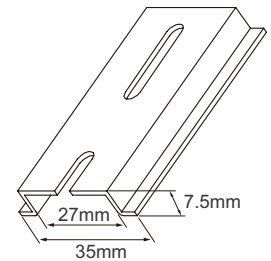
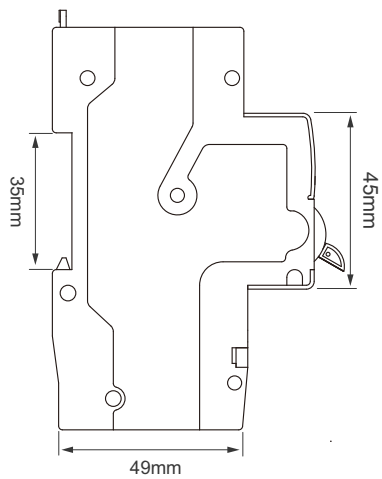
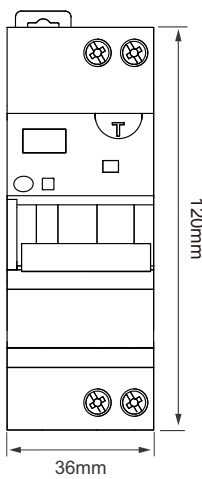

DIN Rail Smart Switch TO-Q-SY1 TO-Q-SY2 Series



Communication method:
W - Wi-Fi, R - RS 485
Z - Zigbee, L - LTE, M - Matter

Rated Current:
6, 10, 16, 20, 25, 32, 40, 50, 63

Series Code

TO
Company Code

Q-SY1

J

Blank:
Without Metering Function
L:
With Metering Protection

W

Platform Technical Support:
T - Tuya, E - eWeLink
X - Mi, C - Customized
M - Tasmota

T

63

DC

Ambient Voltage:
Blank: Alternating Current
DC: Direct Current

DIN Rail Smart Switch TO-Q-SY1 TO-Q-SY2 Series

The TO-Q-SY1 and TO-Q-SY2 are rail-mounted smart series switches, compact in size and versatile in application. They address the issue of limited installation space in circuits, transforming traditional distribution boxes into smart ones. They feature low power consumption, power consumption monitoring, over and under voltage protection, temperature protection, overcurrent protection, and integration with intelligent automation systems.



**Remote
Control**



**Voice
Control**



**Time
Mode**



**Circuit
Protection**



**Electricity
Consumption**



**Real-Time
Power / Current / Voltage**



**Temperature
Protection**



**Operation
Log**



**DIN Rail
Installation**



**Maintenance
Mode**

I TO-Q-SY1 Non-Metering Type



LED Indicator

- The LED indicator flashing blue indicates the network pairing mode.
- The LED indicator solid blue shows the switch is on.
- The LED off indicates the switch is off.

PRODUCT MODEL	TO-Q-SY1-W	TO-Q-SY1-Z	TO-Q-SY1-L	TO-Q-SY1-M
Standards	IEC/EN 60947, IEC/EN 50557, EN 301 489, EN 300 328, EN IEC 61000			
Wiring Mode	DPN 18mm			
Poles Description	Disconnectable L Pole, Direct N Pole			
Operating Rated Voltage	Ue (V)	AC 90 - 240V		
Frequency	Hz	50/60Hz		
Rated Current	In (A)	6, 10, 16, 20, 25, 32, 40, 50, 63		
Operational Safety	Remote setting maintenance switch: which can be set via Apps or other ports to prevent remote accidental switch activation. It requires four consecutive presses to exit maintenance mode			
Communication Protocol	TO-Q-SY1-W	TCP/IP: Wi-Fi (2.412~2.484GHz) IEEE 802.11b/g/n		
	TO-Q-SY1-Z	Zigbee (2.400~2.483GHz) IEEE 802.15.4		
	TO-Q-SY1-L	LTE Cat.1: LTE-FDD: B1/B3/B5/B8 LTE-TDD: B34/38/39/40/41 (2535~2655MHz) LTE-FDD: B1/B3/B5/B7/B8/B20/B28A* LTE-TDD: B38/40/41 GSM/GPRS: GSM900/DCS1800		
	TO-Q-SY1-M	TCP/UDP: Matter		
Energy Consumption Measurement Accuracy	None			
Function Description	Multiple Timing, Remote Control, Voice Control			
Mounting Support	DIN Rail 35mm			

Wiring Diagram

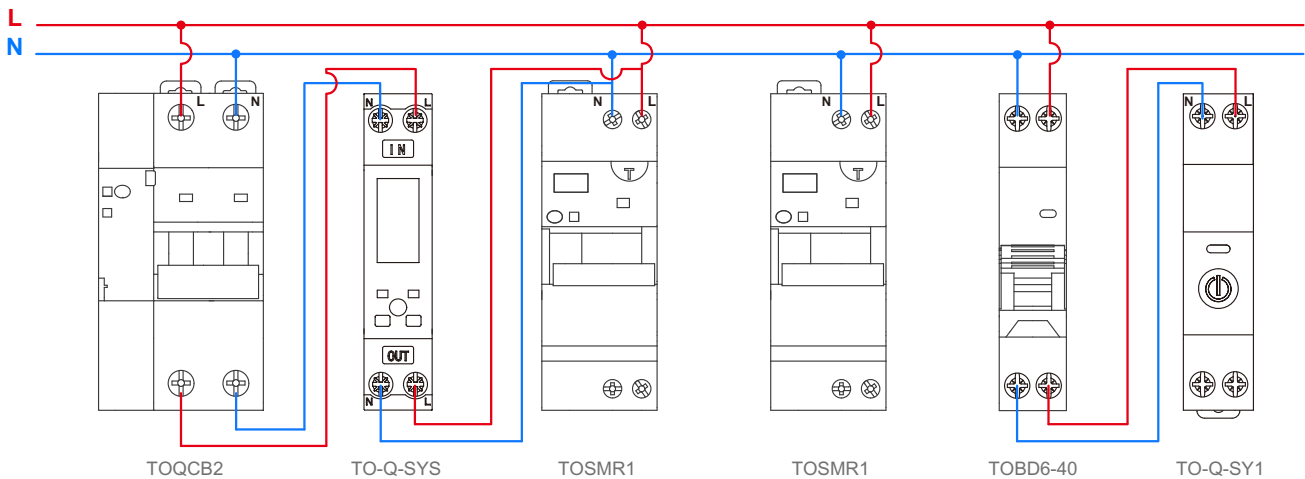

I TO-Q-SY1 Metering Type

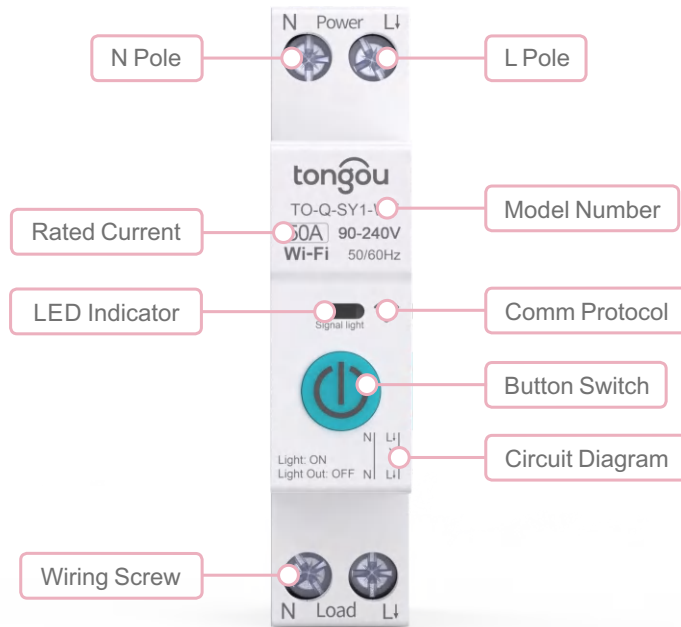

Connection

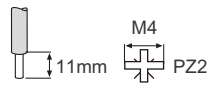
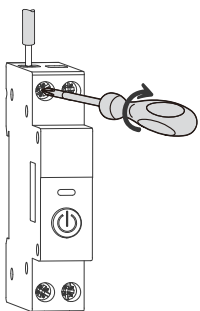

Rating	Tightening torque	Copper cables	
		Rigid	Flexible or ferrule
1 - 50A	1.8 N.m	1 - 16mm ²	1 - 10mm ²
63A	1.8 N.m	16mm ²	/

Dimensions (mm)

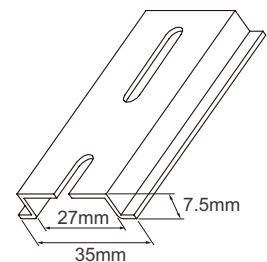
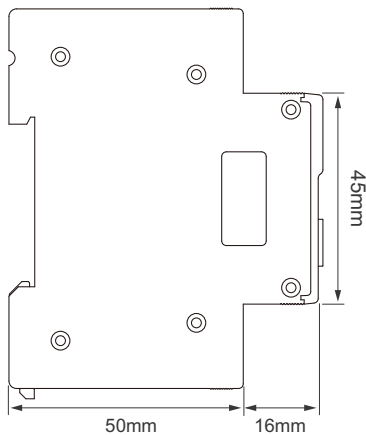
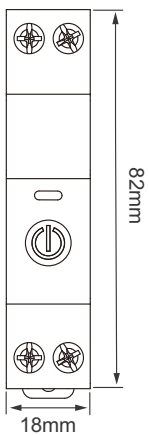

I TO-Q-SY1 Metering Type

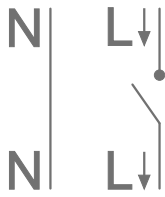

RDT+RELAY



LED Indicator

- The LED indicator flashing blue indicates the device is in pairing mode.
- The LED solid blue shows the network is connected.
- The LED off indicates no network connection.
- The button indicator solid red indicates the switch is on.
- The button indicator off indicates the switch is off.

PRODUCT MODEL	TO-Q-SY1-JW	TO-Q-SY1-JZ	TO-Q-SY1-JL	TO-Q-SY1-JM
Standards	IEC/EN 60947, IEC/EN 50557, EN 301 489, EN 300 328, EN IEC 61000			
Wiring Mode	DPN 18mm			
Poles Description	Disconnectable L Pole, Direct N Pole			
Operating Rated Voltage	Ue (V)	AC 90 - 240V		
Frequency	Hz	50/60Hz		
Rated Current	In (A)	6, 10, 16, 20, 25, 32, 40, 50, 63		
Operational Safety	Remote setting maintenance switch: which can be set via Apps or other ports to prevent remote accidental switch activation. It requires four consecutive presses to exit maintenance mode			
Communication Protocol	TO-Q-SY1-JW	TCP/IP: Wi-Fi (2.412~2.484GHz) IEEE 802.11b/g/n		
	TO-Q-SY1-JZ	Zigbee (2.400~2.483GHz) IEEE 802.15.4		
	TO-Q-SY1-JL	LTE Cat.1: LTE-FDD: B1/B3/B5/B8 LTE-TDD: B34/38/39/40/41 (2535~2655MHz) LTE-FDD: B1/B3/B5/B7/B8/B20/B28A* LTE-TDD: B38/40/41 GSM/GPRS: GSM900/DCS1800		
	TO-Q-SY1-JM	TCP/UDP: Matter		
Energy Consumption Measurement Accuracy	Class 2.0			
Monitoring Physical Data	Real-time Voltage, Real-time Current, Real-time Power (Forward), Power Consumption (Forward), Switch State, Device Operating Status			
Function Description	Multiple Timing, Remote Control, Voice Control			
Mounting Support	DIN Rail 35mm			

Wiring Diagram

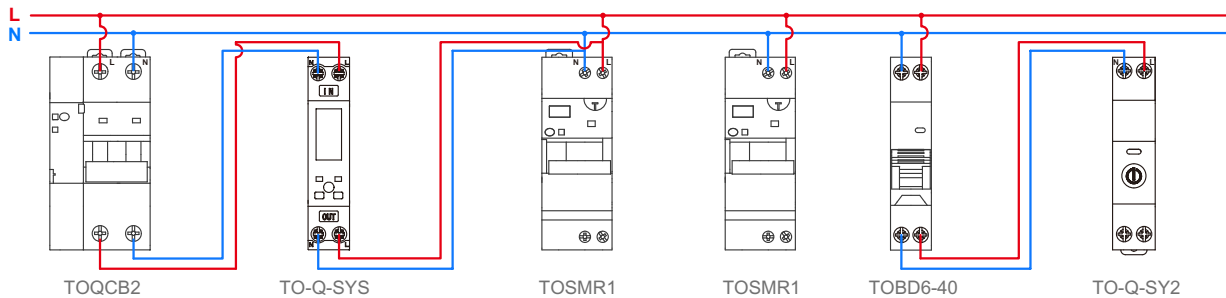

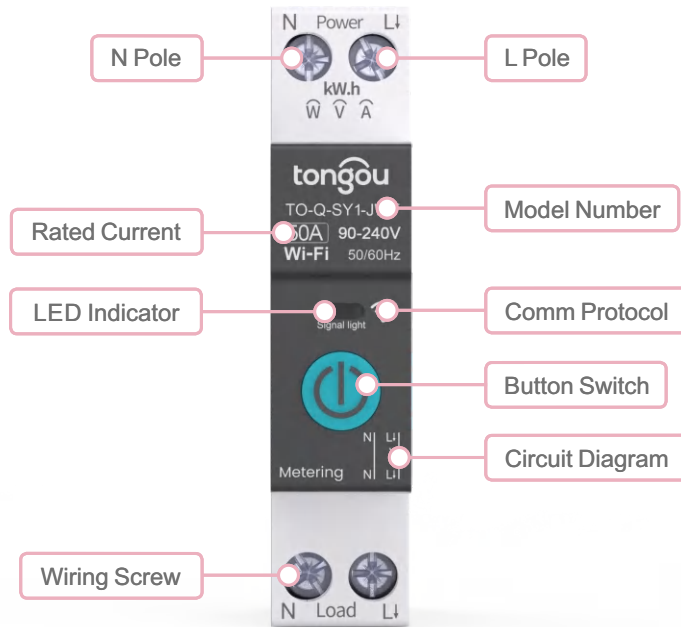

I TO-Q-SY1 Metering Type

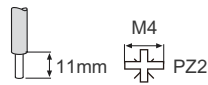
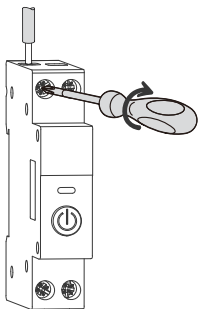

Connection



Rating	Tightening torque	Copper cables	
		Rigid	Flexible or ferrule
1 - 50A	1.8 N.m		
63A	1.8 N.m	16mm ²	/

Dimensions (mm)

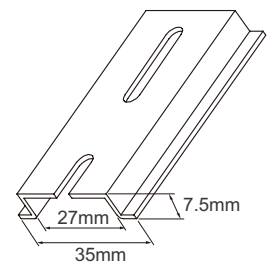
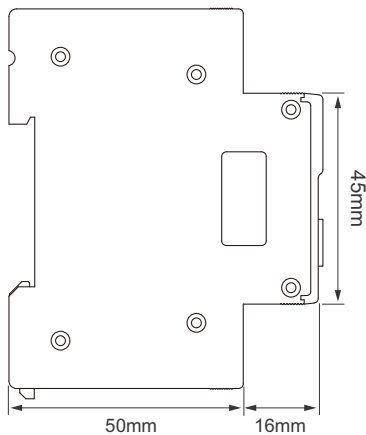
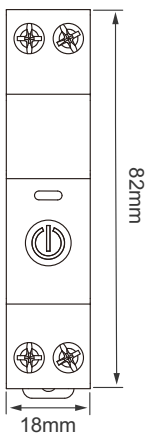

TO-Q-SY2

⚡ Over-Current Protection

Threshold Setting: 1A - 63A
 Status Setting: Off/Alarm/Trip
 Electronic Component Response Time: 5s

+⚡ Over-Voltage Protection

Threshold Setting: 245V - 295A
 Status Setting: Off/Alarm/Trip
 Electronic Component Response Time: 5s

-⚡ Under-Voltage Protection

Threshold Setting: 145V - 220A
 Status Setting: Off/Alarm/Trip
 Electronic Component Response Time: 5s

📶 High Power Protection

Threshold Setting: 1KW - 26KW
 Status Setting: Off/Alarm/Trip
 Electronic Component Response Time: 5s

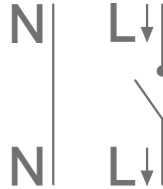

RDT+RELAY+UVP/OVP+ECM



LED Indicator

- 🔦: The LED indicator flashing blue indicates the device is in pairing mode.
- 🔦: The LED solid blue shows the network is connected.
- 🔦: The LED off indicates no network connection.
- 🔴: The button indicator solid red indicates the switch is on.
- ⏻: The button indicator off indicates the switch is off.

PRODUCT MODEL	TO-Q-SY2-JW	TO-Q-SY2-JZ	TO-Q-SY2-JL	TO-Q-SY2-JM
Standards	IEC/EN 60947, IEC/EN 50557, EN 301 489, EN 300 328, EN IEC 61000			
Wiring Mode	DPN 18mm			
Poles Description	Disconnectable L Pole, Direct N Pole			
Operating Rated Voltage Ue (V)	AC 90 - 240V			
Frequency Hz	50/60Hz			
Current Frame In (A)	63			
Operational Safety	Remote setting maintenance switch: which can be set via Apps or other ports to prevent remote accidental switch activation. It requires four consecutive presses to exit maintenance mode			
Communication Protocol	TO-Q-SY2-JW	TCP/IP: Wi-Fi (2.412~2.484GHz) IEEE 802.11b/g/n		
	TO-Q-SY2-JZ	Zigbee (2.400~2.483GHz) IEEE 802.15.4		
	TO-Q-SY2-JL	LTE Cat.1: LTE-FDD: B1/B3/B5/B8 LTE-TDD: B34/38/39/40/41 (2535~2655MHz) LTE-FDD: B1/B3/B5/B7/B8/B20/B28A* LTE-TDD: B38/40/41 GSM/GPRS: GSM900/DCS1800		
	TO-Q-SY2-JM	TCP/UDP: Matter		
Energy Consumption Measurement Accuracy	Class 2.0			
Monitoring Physical Data	Real-time Voltage, Real-time Current, Real-time Power (Forward), Power Consumption (Forward), Switch State, Device Operating Status			
Function Description	Multiple Timing, Over-voltage Protection, Under-voltage Protection, Over-current Protection, Over-Power Protection, Temperature protection, Remote Control, Voice Control			
Mounting Support	DIN Rail 35mm			

Wiring Diagram

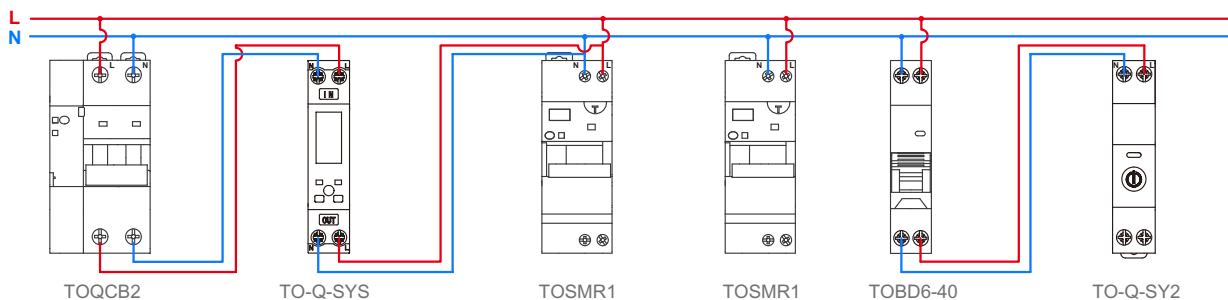

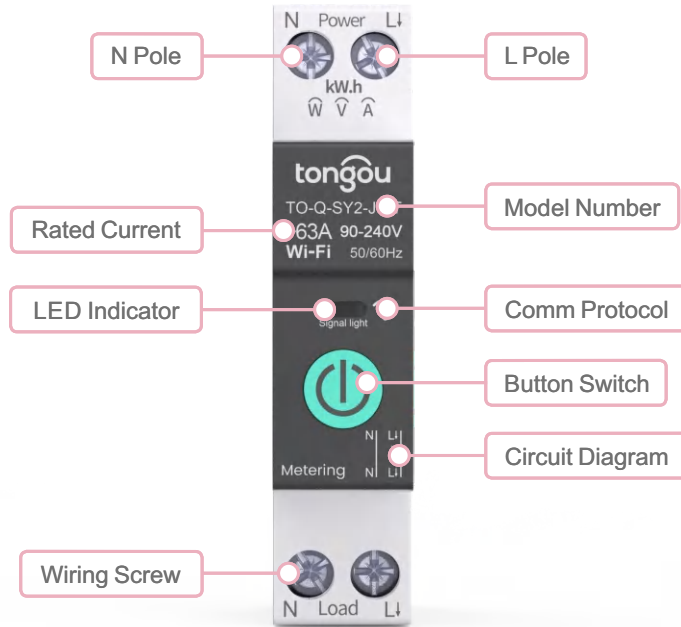

I TO-Q-SY1 Metering Type

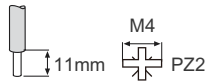
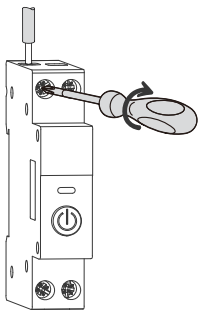

Connection



Rating	Tightening torque	Copper cables	
		Rigid	Flexible or ferrule
1 - 50A	1.8 N.m		
63A	1.8 N.m	16mm ²	/

Dimensions (mm)

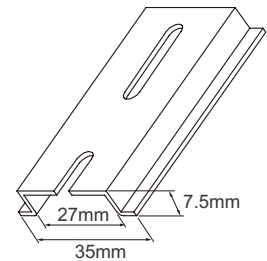
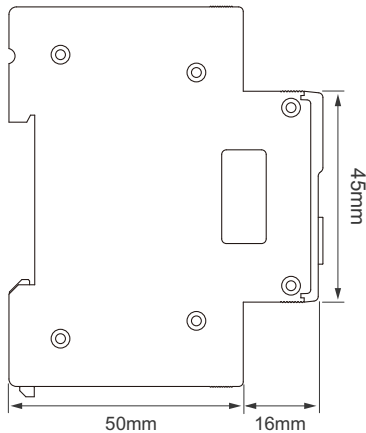
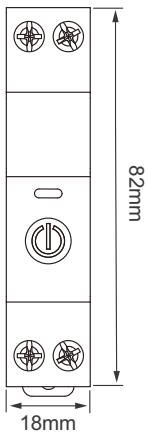

DIN Rail Smart Meter TO-Q-SYS Series

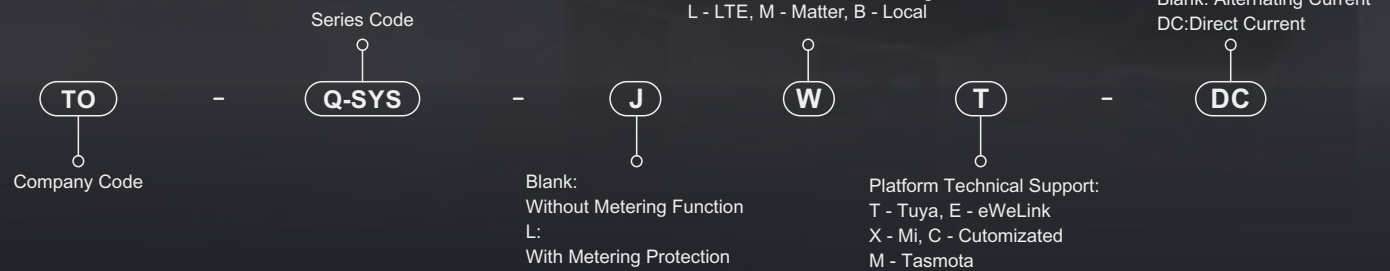

DIN Rail Smart Meter TO-Q-SYS Series

The TO-Q-SYS series rail-mounted smart meters offer compact design, high accuracy, and LCD display for real-time monitoring of voltage, current, and power. They provide local settings, prepaid functionality, and seamless integration with automation systems.



**Remote
Control**



**Voice
Control**



**Time
Mode**



**Circuit
Protection**



**Electricity
Consumption**



**Real-Time
Power / Current / Voltage**



**Temperature
Protection**



**Operation
Log**



**DIN Rail
Installation**



**Maintenance
Mode**



**LCD
Display**

TO-Q-SYS

⚡ Over-current Protection

Threshold Setting: 1A - 50A
 Status Setting: Off/Alarm/Trip
 Tripping Response Time: 3s - 10s (Adjustable)

+⚡ Over-voltage Protection

Threshold Setting: 240V - 295A
 Status Setting: Off/Alarm/Trip
 Tripping Response Time: 3s - 10s (Adjustable)

-⚡ Under-voltage Protection

Threshold Setting: 90V - 220A
 Status Setting: Off/Alarm/Trip
 Tripping Response Time: 3s - 10s (Adjustable)

📶 Over-power Protection

Threshold Setting: 1KW - 26KW
 Status Setting: Off/Alarm/Trip
 Tripping Response Time: 3s - 10s (Adjustable)

🌡 High Temperature Protection



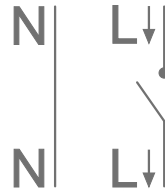





Threshold Setting: -25°C - 80°C
 Status Setting: Off/Alarm/Trip
 Tripping Response Time: 3s - 10s (Adjustable)



RDT+RELAY+UVP/OVP+ECM



LED Indicator

-  : The switch status LED is constantly red, indicating that the Relay is in the connected state.
-  : The switch status LED is black, indicating that the Relay is in the disconnected state.
-  : The network LED is constantly blue, indicating that the network connection is normal.
-  : The network LED is flashing blue, indicating the pairing status.

PRODUCT MODEL	TO-Q-SYS-JW	TO-Q-SYS-JZ	TO-Q-SYS-JL	TO-Q-SYS-JM	TO-Q-SYS-JB
Standards	IEC/EN 60947, IEC/EN 50557, EN 301 489, EN 300 328, EN IEC 61000				IEC/EN 60947
Wiring Mode	DPN 18mm				
Poles Description	Disconnectable L Pole, Direct N Pole				
Operating Rated Voltage	Ue (V)	AC 100 - 240V			
Frequency	Hz	50/60Hz			
Current Frame	In (A)	50			
Operational Safety	Remote setting maintenance switch: which can be set via Apps or other ports to prevent remote accidental switch activation. It requires four consecutive presses to exit maintenance mode (TO-Q-SYS-JB Not)				
Communication Protocol	TO-Q-SYS-JW	TCP/IP: Wi-Fi (2.412~2.484GHz) IEEE 802.11b/g/n			
	TO-Q-SYS-JZ	Zigbee (2.400~2.483GHz) IEEE 802.15.4			
	TO-Q-SYS-JL	LTE Cat.1: LTE-FDD: B1/B3/B5/B8 LTE-TDD: B34/38/39/40/41 (2535~2655MHz) LTE-FDD: B1/B3/B5/B7/B8/B20/B28A* LTE-TDD: B38/40/41 GSM/GPRS: GSM900/DCS1800			
	TO-Q-SYS-JM	TCP/UDP: Matter			
	TO-Q-SYS-JB	Local			
Energy Consumption Measurement Accuracy	Class 1.0				
Initial Current Value	100mA				
Monitoring Physical Data	TO-Q-SYS-JW/TO-Q-SYS-JZ/TO-Q-SYS-JL/TO-Q-SYS-JM Real-time Voltage, Real-time Current, Real-time Power (Forward), Power Consumption (Forward), Switch State, Device Operating Status				
	TO-Q-SYS-JB Local Screen Display				
Function Description	TO-Q-SYS-JW/TO-Q-SYS-JZ/TO-Q-SYS-JL/TO-Q-SYS-JM Multiple Timing, Over-voltage Protection, Under-voltage Protection, Over-current Protection, Over-Power Protection, Temperature protection, Remote Control, Voice Control				
	TO-Q-SYS-JB Multiple Timing, Over-voltage Protection, Under-voltage Protection, Over-current Protection, Over-Power Protection, Temperature Protection				
Mounting Support	DIN Rail 35mm				

TO-Q-SYS

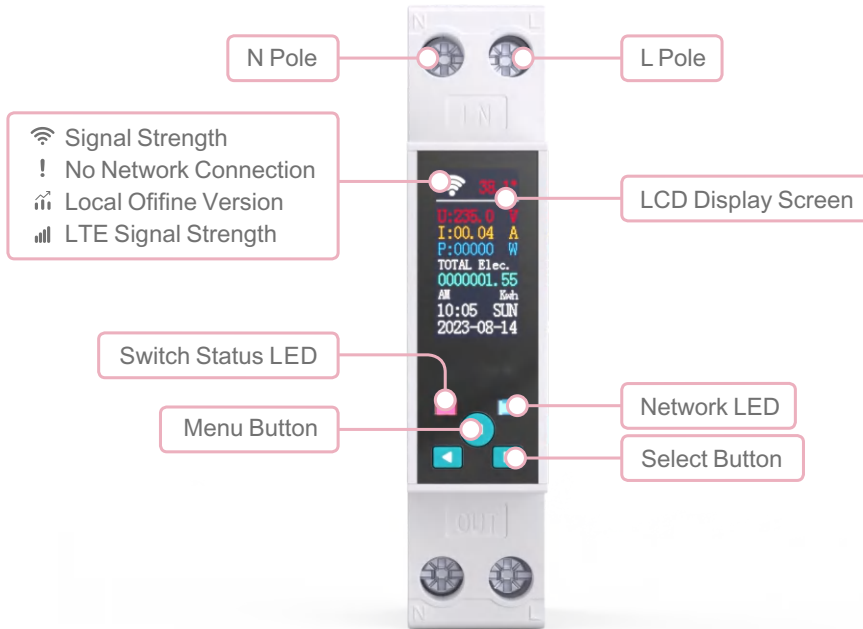

Connection

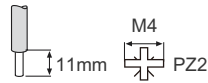
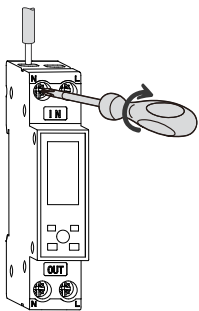

Rating	Tightening torque	Copper cables	
		Rigid	Flexible or ferrule
1 - 50A	1.8 N.m	1 - 16mm ²	1 - 10mm ²
63A	1.8 N.m	16mm ²	/

Dimensions (mm)

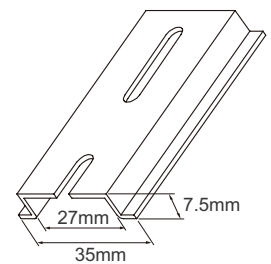
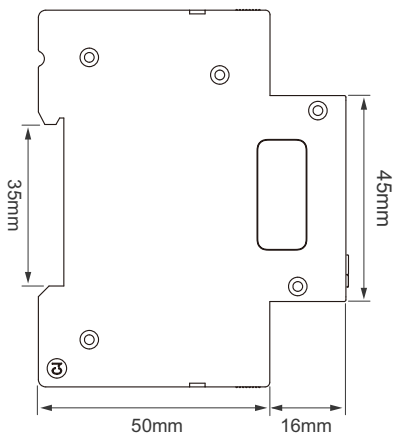
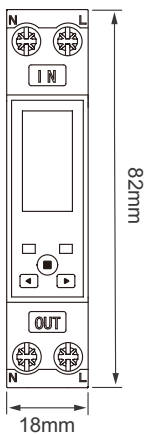

Smart Energy Accessory TO-Q-SA1 Series



Blank:
Mountable Both Top and Bottom
U: Top Installation
D: Bottom Installation

Communication method:
W - Wi-Fi, R - RS 485, Z - Zigbee
L - LTE, M - Matter

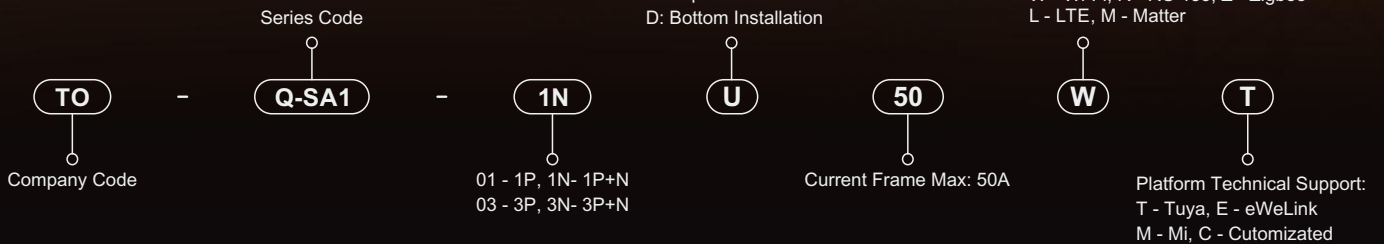



Electricity
Consumption



Real-Time
Power / Current / Voltage



Operation
Log



Circuit
Fault Alarm







High
Temperature Alarm

I TO-Q-SA1



(1P, 1N) RDT+ECM





 Over-current Alarm Threshold Setting: 1A - 50A Status Setting: Off/Alarm	 Over-voltage Alarm Threshold Setting: 245V - 295A Status Setting: Off/Alarm	 Under-voltage Alarm Threshold Setting: 145V - 220A Status Setting: Off/Alarm	 Over-power Alarm Threshold Setting: 5KW - 12KW Status Setting: Off/Alarm
---	--	---	---

PRODUCT MODEL	TO-Q-SA1-0150W	TO-Q-SA1-0150Z	TO-Q-SA1-0150L	TO-Q-SA1-0150M
	TO-Q-SA1-1N50W	TO-Q-SA1-1N50Z	TO-Q-SA1-1N50L	TO-Q-SA1-1N50M
Standards	IEC/EN 50557, EN 301 489, EN 300 328, EN IEC 61000			
Nominal Voltage	Un (V)	AC 230V		
Operating Rated Voltage	Ue (V)	AC 110- 240V		
Operating Temperature		- 25°C to +60°C/ -13°F to + 140°F		
Frequency	Hz	50/60Hz		
Current Frame Maximum	In (A)	50		
Communication Protocol	TO-Q-SA1-0150W/TO-Q-SA1-1N50W		TCP/IP: Wi-Fi (2.412~2.484GHz) IEEE 802.11b/g/n	
	TO-Q-SA1-0150Z/TO-Q-SA1-1N50Z		Zigbee (2.400~2.483GHz) IEEE 802.15.4	
	TO-Q-SA1-0150L/TO-Q-SA1-1N50L		LTE Cat.1: LTE-FDD: B1/B3/B5/B8 LTE-TDD: B34/38/39/40/41 (2535~2655MHz) LTE-FDD: B1/B3/B5/B7/B8/B20/B28A* LTE-TDD: B38/40/41 GSM/GPRS: GSM900/DCS1800	
	TO-Q-SA1-0150M/TO-Q-SA1-1N50M		TCP/UDP: Matter	
Energy Consumption Measurement Accuracy		Class 2.0		
Initial Current Value		100mA		
Monitoring Physical Data		Real-time Voltage, Real-time Current, Real-time Power (Forward), Power Consumption (Forward), Internal Temperature		
Function Description		Over-voltage Alarm, Under-voltage Alarm, Over-current Alarm, Over-Power Alarm, Temperature Alarm, Prepaid Monitoring		
Matched Model of MCB		TOMD6-63		

I TO-Q-SA1



(3P, 3N) RDT+ECM

 Over-current Alarm Threshold Setting: 1A - 50A Status Setting: Off/Alarm	 Over-voltage Alarm Threshold Setting: 245V - 295A Status Setting: Off/Alarm	 Under-voltage Alarm Threshold Setting: 145V - 220A Status Setting: Off/Alarm	 Over-power Alarm Threshold Setting: 5KW - 12KW Status Setting: Off/Alarm
---	--	---	---

PRODUCT MODEL	TO-Q-SA1-0350W	TO-Q-SA1-0350Z	TO-Q-SA1-0350L	TO-Q-SA1-0350M
	TO-Q-SA1-3N50W	TO-Q-SA1-3N50Z	TO-Q-SA1-3N50L	TO-Q-SA1-3N50M
Standards	IEC/EN 50557, EN 301 489, EN 300 328, EN IEC 61000			
Nominal Voltage	Un (V)	AC 230/400V		
Operating Rated Voltage	Ue (V)	TO-Q-SA1-0350W/3N50W	TO-Q-SA1-0350Z/3N50Z: AC 230V	
		TO-Q-SA1-0350L/3N50L	TO-Q-SA1-0350M/3N50M: AC 110- 240V (L1-N, L2-N, L3-N)	
Operating Temperature		- 25°C to +60°C/ -13°F to + 140°F		
Frequency	Hz	50/60Hz		
Current Frame Maximum	In (A)	50		
Communication Protocol		TO-Q-SA1-0150W/TO-Q-SA1-1N50W	TCP/IP: Wi-Fi (2.412~2.484GHz) IEEE 802.11b/g/n	
		TO-Q-SA1-0150Z/TO-Q-SA1-1N50Z	Zigbee (2.400~2.483GHz) IEEE 802.15.4	
		TO-Q-SA1-0150L/TO-Q-SA1-1N50L	LTE Cat.1: LTE-FDD: B1/B3/B5/B8 LTE-TDD: B34/38/39/40/41 (2535~2655MHz) LTE-FDD: B1/B3/B5/B7/B8/B20/B28A* LTE-TDD: B38/40/41 GSM/GPRS: GSM900/DCS1800	
		TO-Q-SA1-0150M/TO-Q-SA1-1N50M	TCP/UDP: Matter	
Energy Consumption Measurement Accuracy		Class 2.0		
Initial Current Value		100mA		
Monitoring Physical Data		Real-time Voltage, Real-time Current, Real-time Power (Forward), Power Consumption (Forward), Internal Temperature		
Function Description		Over-voltage Alarm, Under-voltage Alarm, Over-current Alarm, Over-Power Alarm, Temperature Alarm, Prepaid Monitoring		
Matched Model of MCB		TOMD6-63		

TO-Q-SA1

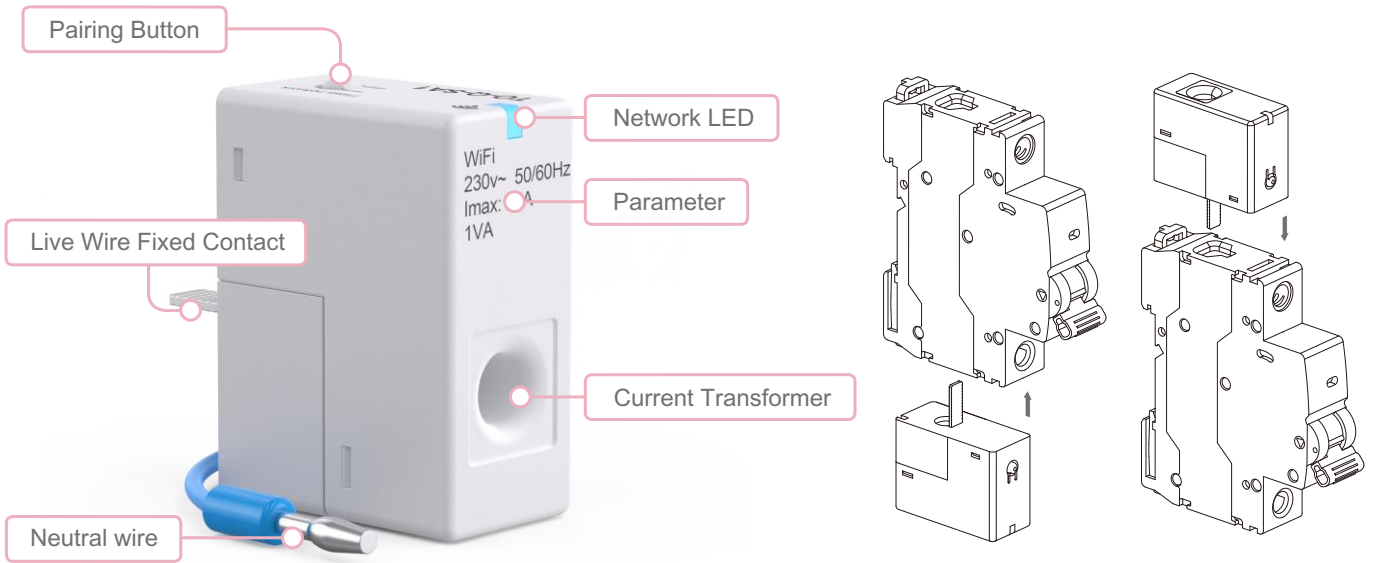

Wiring Diagram

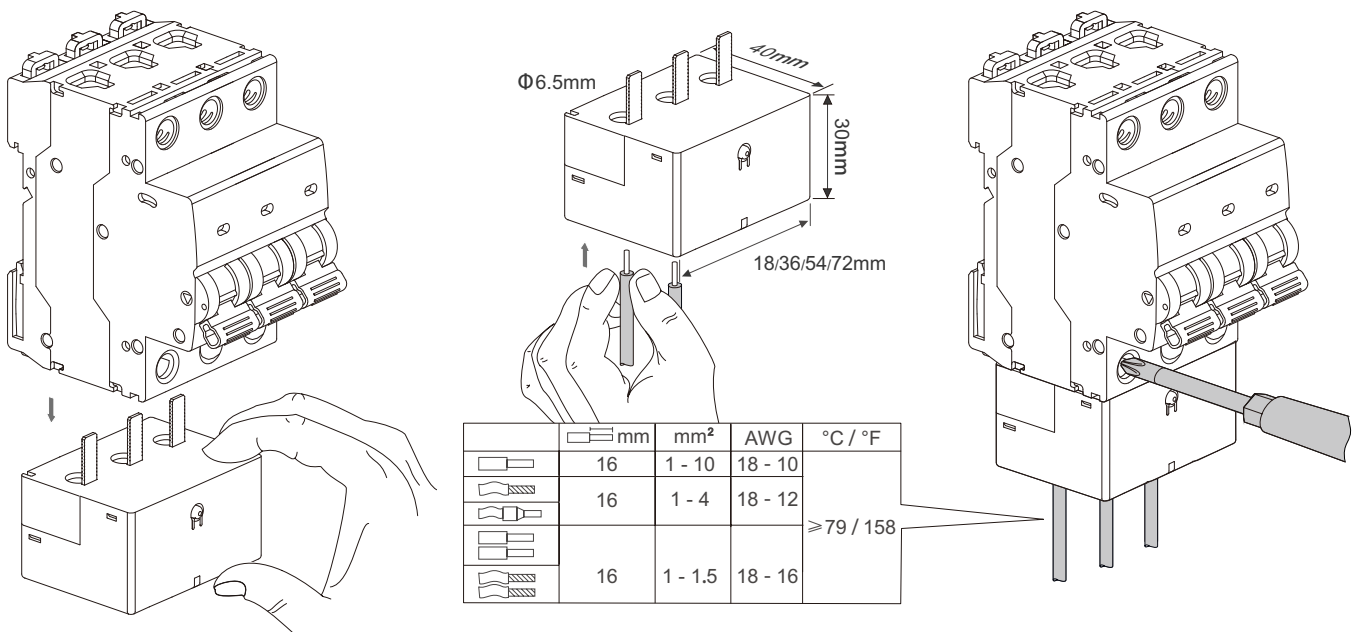
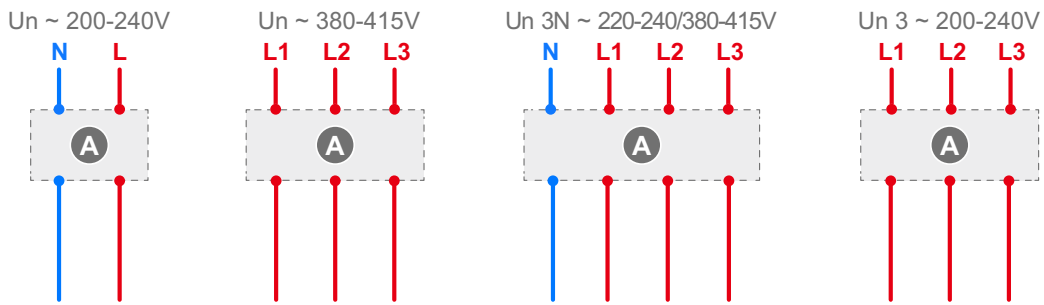



| Note



Tongou Smart



@tongou



Tongou Smart

Changyou Technology (Zhejiang) Co.,Ltd

1005 Xianggang Rd, Paidong Industrial 325604 Liushi Town
Wenzhou City, Zhejiang Province China

 www.elcb.net

 elcb@elcb.net



© 2024 Changyou Technology. All Rights Reserved.
Tongou is a trademark and the property of Changyou Technology, its subsidiaries and affiliated companies.

This document has been
printed on recycled paper 